

# ***COMMUNITY EMERGENCY RESPONSE TEAM***

## ***Participant Manual***

**Developed For:  
Department of Homeland Security  
United States Fire Administration  
Emergency Management Institute**

**Developed By:  
Human Technology, Inc.  
McLean, Virginia**





**ACKNOWLEDGEMENTS**

The Community Emergency Response Team (CERT) concept was developed and implemented by the City of Los Angeles Fire Department (LAFD) in 1985. They recognized that citizens would very likely be on their own during the early stages of a catastrophic disaster. Accordingly, LAFD decided that some basic training in disaster survival and rescue skills would improve the ability of citizens to survive until responders or other assistance could arrive. The Whittier Narrows earthquake in 1987 underscored the area-wide threat of a major disaster in California. Further, it confirmed the need for training civilians to meet immediate post-disaster needs.

The training program that the LAFD initiated proved to be so beneficial that the Federal Emergency Management Agency (FEMA) felt that the concept and the program should be made available to communities nationwide. In 1994, the Emergency Management Institute (EMI), in cooperation with the LAFD, expanded the CERT materials to make them applicable to all hazards.

In 2003, President Bush asked all Americans to volunteer in the service of their country. The Citizen Corps program was created to spearhead this effort to harness the power of every individual through education, training, and volunteer service to make communities safer, stronger, and better prepared to respond to the threats of terrorism, crime, public health issues, and disasters of all kinds. CERT was selected as one of the primary programs offered to the American public to meet this challenge.

EMI would like to thank the following people who participated in a focus group to review and evaluate the CERT material.

Lt. Stewart Anderson  
Natrona County Emergency Management Agency  
Casper, WY

Robert Bohlmann  
York County Emergency Management Agency  
Alfred, Maine

Lt. Bill Empey  
City of Rochester Fire Department  
Rochester, New York

Chandra Fox  
Emergency Services Coordinating Agency  
Edmonds, Washington

Rachel Jacky  
Portland Fire Bureau  
Portland, Oregon

---

**COMMUNITY EMERGENCY RESPONSE TEAM**

**ACKNOWLEDGEMENTS**

---

**ACKNOWLEDGEMENTS (CONTINUED)**

Dale Kloes  
Whatcom County Sheriff's Office  
Bellingham, Washington

Captain Don Lee  
Los Angeles Fire Department  
Sherman Oaks, California

Frank Lucier  
North American Emergency Management  
Napa, California

Captain Robert Palestrant  
Miami-Dade Fire Department  
Miami, Florida

Chief Harry Small  
Pompano Beach Fire Department  
Pompano Beach, Florida

EMI would also like to thank the following reviewers of draft material: Mark Penn, Arlington Fire Department; John Moede, LA City Fire Department, Corey Barton, Ogden Fire Department; Joel Kasprzak, Portland Fire and Rescue, and Kevin Shanders, Portland Fire and Rescue.

**ABOUT COMMUNITY EMERGENCY RESPONSE TEAM (CERT) TRAINING**

If available, emergency services personnel are the best trained and equipped to handle emergencies, and you should use them. However, following a catastrophic disaster, you and the community may be on your own for a period of time because of the size of the area affected, lost communications, and unpassable roads.

CERT training is designed to prepare you to help yourself, your family, and your neighbors in the event of a catastrophic disaster. Because emergency services personnel will not be able to help everyone immediately, you can make a difference by using the training in this Participant Manual to save lives and protect property.

This training covers basic skills that are important to know in a disaster when emergency services are not available. With training and practice and by working as a team, you will be able to do the greatest good for the greatest number of victims after a disaster, while protecting yourself from becoming a victim.

---



**WHEN DISASTER STRIKES**

The damage caused by natural disasters and man-made events such as earthquakes, hurricanes, tornadoes, flooding, and terrorism can affect all elements of society and government. These events:

- Severely restrict or overwhelm our response resources, communications, transportation, and utilities.
- Leave many individuals and neighborhoods cut off from outside support.

It takes time for emergency response agencies to set up and prepare for an organized response, and damaged roads and disrupted communications systems may restrict their access into critically affected areas. Thus, for the initial period immediately following a disaster—often up to 3 days or longer—individuals, households, and neighborhoods may need to rely on their own resources for:

- Food.
- Water.
- First aid.
- Shelter.

Individual preparedness, planning, survival skills, and mutual aid within neighborhoods and worksites during this initial period are essential measures in coping with the aftermath of a disaster.

---

**COMMUNITY PREPAREDNESS**

Community-based preparedness planning allows us to prepare for and respond to anticipated disruptions and potential hazards following a disaster. As individuals, we can prepare our homes and families to cope during that critical period. Through pre-event planning, neighborhoods and worksites can also work together to help reduce injuries, loss of lives, and property damage. Neighborhood preparedness will enhance the ability of individuals and neighborhoods to reduce their emergency needs and to manage their existing resources until professional assistance becomes available.

Studies of behavior following disasters have shown that groups working together in the disaster period perform more effectively if there has been prior planning for disaster response. These studies show that organized grassroots efforts may be more successful if they are woven into the social and political fabric of the community—neighborhood associations, schools, workplaces, places of worship, and other existing organizations.

Effective response therefore requires comprehensive planning and coordination of all who will be involved—government, volunteer groups, private businesses, schools, and community organizations. With training and information, individuals and community groups can be prepared to serve as a crucial resource capable of performing many of the emergency functions needed in the immediate post-disaster period. The Community Emergency Response Team (CERT) program is designed to help communities prepare for effective disaster response through training and planning.

---



### **HOW CERTS OPERATE**

As each CERT is organized and trained and in accordance with standard operating procedures developed by the sponsoring agency, its members select a team leader and an alternate and identify a meeting location, or *staging area*, to be used in the event of a disaster.

The staging area is where the fire department and other services will interact with CERTs. Having a centralized contact point makes it possible to communicate damage assessments and allocate volunteer resources more effectively.

Damage from disasters may vary considerably from one location to another. In an actual disaster, CERTs are deployed progressively and as needs dictate. Members are taught to assess their own needs and those in their immediate environment first.

CERT members who encounter no need in their immediate area then report to their staging area, where they take on assigned roles based on overall area needs. Members who find themselves in a heavily affected location send runners to staging areas to get help from available resources. Ham and CB radio links also may be used to increase communication capabilities and coordination.

The CERT program can provide an effective first-response capability. Acting as individuals first, then later as members of teams, trained CERT volunteers can fan out within their assigned areas, extinguishing small fires, turning off natural gas inlets to damaged homes, performing light search and rescue, and rendering basic medical treatment. Trained volunteers also offer an important potential workforce to service organizations in nonhazardous functions such as shelter support, crowd control, and evacuation.

---

**THE CERT TRAINING PROGRAM**

In the next 9 sessions, you will be trained in such basic self-help and mutual-aid emergency functions as:

- Disaster preparedness.
- Fire safety.
- Disaster medical operations (2 sessions).
- Light search and rescue.
- CERT organization.
- Disaster Psychology.
- Terrorism and CERT.

Classes are taught by trained emergency personnel, including firefighters and Emergency Medical Services (EMS) personnel. The program consists of 20 hours of training and emphasizes hands-on practice.

# COMMUNITY EMERGENCY RESPONSE TEAM

## INTRODUCTION

### THE CERT TRAINING PROGRAM (CONTINUED)

CERT training is divided into 9 units covering the following topics:

Unit	Topics Covered
1. Disaster Preparedness	<ul style="list-style-type: none"><li>▪ Introductions</li><li>▪ Recent Disasters and Emergencies</li><li>▪ Course Preview</li><li>▪ Disasters and Disaster Workers</li><li>▪ Impact on the Infrastructure</li><li>▪ Structural and Nonstructural Hazards</li><li>▪ Hazard Mitigation</li><li>▪ Home and Workplace Preparedness</li><li>▪ Community Preparedness</li><li>▪ Protection for Disaster Workers</li></ul>
2. Fire Safety	<ul style="list-style-type: none"><li>▪ Fire chemistry</li><li>▪ Reducing Fire Hazards in the Home and Workplace</li><li>▪ Hazardous Materials</li><li>▪ CERT Sizeup</li><li>▪ Firefighting Resources</li><li>▪ Fire Suppression Safety</li></ul>
3. Disaster Medical Operations Part 1	<ul style="list-style-type: none"><li>▪ Treating Life-Threatening Conditions</li><li>▪ Triage</li></ul>
4. Disaster Medical Operations Part 2	<ul style="list-style-type: none"><li>▪ Public Health Considerations</li><li>▪ Functions of Disaster Medical Operations</li><li>▪ Establishing Treatment Areas</li><li>▪ Conducting Head-to-Toe Assessments</li><li>▪ Treating Burns</li><li>▪ Wound Care</li><li>▪ Treating Fractures, Sprains, and Strains</li><li>▪ Splinting</li><li>▪ Nasal Injuries</li><li>▪ Treating Hypothermia</li></ul>
5. Light Search And Rescue Operations	<ul style="list-style-type: none"><li>▪ Search and Rescue Sizeup</li><li>▪ Conducting Search Operations</li><li>▪ Conducting Rescue Operations</li></ul>
6. CERT Organization	<ul style="list-style-type: none"><li>▪ CERT Organization</li><li>▪ CERT Decisionmaking</li><li>▪ Documentation</li></ul>
7. Disaster Psychology	<ul style="list-style-type: none"><li>▪ Team Well-Being</li><li>▪ Working with Survivors' Trauma</li></ul>

---

## COMMUNITY EMERGENCY RESPONSE TEAM

### INTRODUCTION

---

#### THE CERT TRAINING PROGRAM (CONTINUED)

Unit	Topics Covered
8. Terrorism and CERT	<ul style="list-style-type: none"><li>▪ What is Terrorism</li><li>▪ Terrorist Targets</li><li>▪ Terrorist Weapons</li><li>▪ B-NICE Indicators</li><li>▪ Preparing at Home and Work</li><li>▪ CERTs and Terrorist Incidents</li></ul>
9. Course Review and Disaster Simulation	<ul style="list-style-type: none"><li>▪ Course Review</li><li>▪ Disaster Simulation</li></ul>

Upon completion of the course, you will receive a certificate and may receive identification that will identify you as an emergency response team member during disaster response. You should maintain additional safety equipment, such as goggles, gloves, and basic first aid supplies and have them available for use during a disaster. (If you are a member of a business or industry training group, your employer may supply these items for you.)

Training in disaster response should not be a one-time event. Awareness, commitment, and skills must be reinforced through follow-up training and repeated practice to maintain the edge necessary for effective response in the face of a disaster. To maintain your skill level and continually improve performance, you and your team members should participate in continuing supplemental training when offered in your area. Working through practice disaster scenarios with other teams will provide opportunities not only for extended practice but for valuable networking with teams in the local area.

---

**Acknowledgements** ..... |

**Foreword**..... |

**Introduction** ..... |

**Unit 1: Disaster Preparedness**

Welcome and Introductions ..... 1-1

Activity: Building a Tower..... 1-1

Introduction and Unit Overview ..... 1-1

Recent Disasters and Emergencies ..... 1-2

Course Preview..... 1-5

Disaster and Disaster Workers..... 1-5

Impact on the Infrastructure..... 1-6

Structural and Nonstructural Hazards ..... 1-7

Hazard Mitigation ..... 1-8

Home and Workplace Preparedness ..... 1-9

Community Preparedness ..... 1-20

Protection for Disaster Workers..... 1-22

Unit Summary ..... 1-23

Additional Materials

Appendix 1-A: Hazard Lesson Plans

**Unit 2: Fire Safety**

Introduction and Unit Overview ..... 2-1

Fire Chemistry..... 2-3

Reducing Fire Hazards in the Home and Workplace..... 2-4

CERT Sizeup ..... 2-9

Firefighting Resources..... 2-16

Fire Suppression Safety ..... 2-22

Hazardous Materials ..... 2-24

Exercise: Suppressing Small Fires..... 2-29

Unit Summary ..... 2-31

**Unit 3: Disaster Medical Operations—Part 1**

Introduction and Unit Overview ..... 3-1

Treating Life-Threatening Conditions ..... 3-3

Triage ..... 3-13

Unit Summary ..... 3-19

---

**COMMUNITY EMERGENCY RESPONSE TEAM**  
**TABLE OF CONTENTS**

---

**PAGE**

**Unit 4: Disaster Medical Operations—Part 2**

Introduction and Unit Overview .....	4-1
Public Health Considerations.....	4-2
Functions of Disaster Medical Operations.....	4-4
Establishing Treatment Areas.....	4-6
Conducting Head-to-Toe Assessments.....	4-9
Treating Burns.....	4-13
Wound Care.....	4-15
Treating Fractures, Dislocations, Sprains, and Strains.....	4-17
Splinting.....	4-20
Nasal Injuries .....	4-22
Treating Hypothermia .....	4-23
Unit Summary .....	4-25

**Unit 5: Light Search and Rescue Operations**

Introduction and Unit Overview .....	5-1
Search and Rescue Sizeup .....	5-2
Conducting Search Operations .....	5-19
Conducting Rescue Operations.....	5-23
Unit Summary .....	5-31
Additional Materials	

**Unit 6: CERT Organization**

Introduction and Unit Overview .....	6-1
CERT Organization.....	6-1
CERT Decisionmaking.....	6-6
Documentation .....	6-9
Tabletop Exercise .....	6-19
Unit Summary .....	6-20
Appendix 6-A: CERT Forms	

**Unit 7: Disaster Psychology**

Introduction and Unit Overview .....	7-1
Team Well-Being .....	7-1
Working with Survivors' Trauma.....	7-5
Unit Summary .....	7-8

**Unit 8: Terrorism and CERT**

Introduction and Unit Overview ..... 8-1  
What is Terrorism?..... 8-2  
Terrorist Targets..... 8-3  
Terrorist Weapons ..... 8-3  
B-NICE Indicators ..... 8-7  
Preparing at Home and Work..... 8-8  
CERTs and Terrorist Incidents ..... 8-9  
Unit Summary ..... 8-14

**Unit 9: Course Review and Disaster Simulation**

Introduction and Unit Overview ..... 9-1  
Course Review..... 9-1  
Exercise Critique and Summary..... 9-5





---

# UNIT 1: DISASTER PREPAREDNESS

---

---

## In this unit you will learn about:

- **Disasters and Disaster Workers:** What defines a disaster, what defines an disaster, and who makes up the response workforce.
- **The Impact on the Infrastructure:** The potential effect of extreme emergencies and disasters on transportation; electrical service; telephone communication; fuel; food, water, and shelter; and emergency services.
- **Structural and Nonstructural Hazards:** Potentially hazardous conditions in various types of structures and their contents during a disaster.
- **Hazard Mitigation:** What to do to reduce the risk of damage from hazards that threaten your area.
- **Home and Workplace Preparedness:** How you can prepare in advance to reduce structural and nonstructural hazards and survive the initial period after a disaster.
- **Community Preparedness:** How a community can prepare in advance to respond.
- **Protection for Disaster Workers:** Laws that protect disaster workers from liability.



**UNIT 1: DISASTER PREPAREDNESS**

---

**WELCOME AND INTRODUCTIONS**

The introduction section in your Participant Manuals contains excellent information on:

- When an disaster strikes.
  - Community preparedness.
  - How CERT teams operate.
  - The CERT training program.
- 

**ACTIVITY: BUILDING A TOWER**

**Instructions:** Follow the steps below to complete this exercise:

1. You will work in groups of five.
2. You will spend the next 10 minutes planning and designing a free-standing tower that stands at least five feet tall from the bottom of the structure to the top. You will be told when to begin and will have 5 minutes from that point to construct the tower.

The skills and abilities that you used during this exercise are the same skills that you will use as CERT members.

---

**INTRODUCTION AND UNIT OVERVIEW**

**UNIT OBJECTIVES**

At the end of this unit, you should be able to:

- Describe the types of hazards most likely to affect your home and community.
  - Describe the functions of CERTs and their role in immediate response.
  - Identify steps to prepare for emergencies.
-

**RECENT DISASTERS AND EMERGENCIES**

Emergency response personnel cooperate at many levels to provide immediate response capabilities.

Emergency service capability can be greatly enhanced by well-organized, well-trained, and well-managed CERTs that are able to:

- Prepare in advance of a disaster event.
- Respond in their communities to address immediate needs brought about by the disaster.

As CERT members, your role is to prepare for a disaster by:

- Identifying potential structural and nonstructural hazards in your home and workplace.
- Reducing the hazards to the degree possible before a disaster strikes.
- Developing a disaster supply kit.

CERTs respond after a disaster by:

- Locating and turning off utilities, if safe to do so.
- Extinguishing small fires.
- Treating life-threatening injuries until professional assistance can be obtained.
- Conducting light search and rescue operations.
- Helping disaster survivors cope with their emotional stressors.

The key CERT functions include:

- Fire safety.
- Medical operations.
- Light search and rescue.
- Disaster psychology.

**RECENT DISASTERS AND EMERGENCIES (CONTINUED)****CERTs IN DISASTER ROLES**

There are many instances of CERT members' participation in disaster response.

During the Northridge Earthquake, the following use of CERTs were recorded:

- Search: 203
- Rescue: 17
- Medical treatment: 57
- Patient transport: 4
- Fire suppression: 5
- Utility control: 156

In Alachua County, FL, during Hurricane Floyd in 1999 and during Tropical Storm Gordon in 2000, CERTs were called by the EOC to contact special-needs residents to ensure that they were aware of the approaching storms and to ascertain whether they would use the county's special needs shelters and transportation. The CERTs arranged transportation, as necessary.

About a dozen CERTs were used during the Hidden Lake and Lake Louise fires in 2000 to provide food for the firefighters, move supplies, and assist with preparation in the area.

The CERT concept has extended from its original purpose as a response operation following catastrophic disasters. CERTs are now activated for a wide range of emergencies. For example, in Whatcom County, WA, CERT members were used in the following situations:

- Whatcom Creek gasoline pipeline explosion (Olympic Pipeline)
- Explosion at the Georgia-Pacific Pulp & Paper Mill
- Y2K Emergency Operations Center (EOC) activation
- Sandy Point wind and flood event
- Nisqually earthquake

The CERT members who responded to the Whatcom Creek incident received The American Red Cross Real Heroes award for their contributions. CERT members in the county have received Federal, State, and local recognition for their response efforts.

**RECENT DISASTERS AND EMERGENCIES (CONTINUED)****CERTs IN NONDISASTER ROLES**

CERT members also are a potential volunteer pool for the community. They can help with projects such as:

- Distributing preparedness materials.
- Staffing medical booths during special events.
- Assisting with the installation of smoke alarms for seniors and special-needs households.

Additionally, in his January 29, 2002, State of the Union address, the President asked that Americans volunteer their services to improve and safeguard our country. The three areas of emphasis for these volunteer efforts are crime, natural disasters, and terrorism. The Citizen Corps Program was created to help Americans meet this call to service. One of the volunteer opportunities offered to the American public under the Citizen Corps umbrella is the CERT program.

After completing initial CERT training, many CERT members seek to expand and improve their skills—through continuing CERT modules offered locally, courses offered through The American Red Cross, or programs from other sources. Some CERT members have sought additional training opportunities in:

- Shelter management.
  - Community relations.
  - Donations management.
  - Special needs concerns.
  - Debris removal.
  - Utilities control.
  - Advanced first aid.
  - Automated External Defibrillator use.
  - CPR skills.
-

### COURSE PREVIEW

This unit will provide an overview of the course by establishing a context for CERTs within the specific hazards faced by the community.

Later units will cover:

- Fire safety.
  - Disaster medical operations.
  - Light search and rescue.
  - CERT organization.
  - Disaster psychology.
  - CERTs and terrorism.
- 

### DISASTERS AND DISASTER WORKERS

Disasters can be:

- Natural.
- Manmade.
- Technological.

Regardless of the event, disasters have several key elements in common:

- They are relatively unexpected, with little or no warning or opportunity to prepare.
- Available personnel and emergency services may be overwhelmed initially by demands for their services.
- Lives, health, and the environment are endangered.

In the immediate aftermath of a disaster, needs will be greater than professional emergency services personnel can provide. In these instances, CERTs become a vital link in the emergency service chain.

---

---

**COMMUNITY EMERGENCY RESPONSE TEAM****UNIT 1: DISASTER PREPAREDNESS**

---

**IMPACT ON THE INFRASTRUCTURE****Possible Effects of Damage on Emergency Service Providers**

<b>Damage to . . .</b>	<b>Possible Effects</b>
Transportation	<ul style="list-style-type: none"><li>▪ Inability to assess damage accurately</li><li>▪ Ambulances prevented from reaching victims</li><li>▪ Police prevented from reaching areas of civil unrest</li><li>▪ Fire departments prevented from getting to fires</li><li>▪ Flow of needed supplies is interrupted</li></ul>
Structures	<ul style="list-style-type: none"><li>▪ Damaged hospitals unable to function normally</li><li>▪ Increased risk of damage from falling debris</li></ul>
Communication Systems	<ul style="list-style-type: none"><li>▪ Victims unable to call for help</li><li>▪ Coordination of services is hampered</li></ul>
Utilities	<ul style="list-style-type: none"><li>▪ Loss of utilities</li><li>▪ Increased risk of fire or electrical shock</li><li>▪ Loss of contact between victims and service providers</li><li>▪ Inadequate water supply</li><li>▪ Increased risk to public health</li></ul>
Water Service	<ul style="list-style-type: none"><li>▪ Firefighting capabilities restricted</li><li>▪ Medical facilities hampered</li></ul>
Fuel Supplies	<ul style="list-style-type: none"><li>▪ Increased risk of fire or explosion from fuel line rupture</li><li>▪ Risk of asphyxiation</li></ul>

Because emergency services personnel are likely to have inadequate resources to meet the public's needs, those resources must be applied according to the highest-priority need.

- Police will address incidences of grave public safety.
- Firefighters will suppress major fires.
- EMS personnel will handle life-threatening injuries. (However, CERTs will also handle life-threatening injuries until EMS units become available.)

Lower-priority needs will have to be met in other ways.

---



### **STRUCTURAL AND NONSTRUCTURAL HAZARDS**

Shutting off or raising utilities is one way to reduce—or mitigate—a hazard before a disaster occurs. Shutting off utilities is one way to mitigate a hazard immediately after a disaster.

The mitigation steps that one should take before and immediately after a disaster depend on the hazard and type of structure. This topic will deal with types of structures and the hazards related to each. Safety precautions, including hazard mitigation for structural and nonstructural hazards, will be covered next.

#### **HAZARDS RELATED TO STRUCTURE TYPE**

You might not have an opportunity to select the type of structure that you are in when a disaster occurs. It is important to know what type of damage to expect from the main types of structures in the community.

Engineered buildings, such as most high-rise buildings, have performed well in most types of disasters. During earthquakes and high-wind events (e.g., tornadoes, hurricanes), older high-rise buildings, however, are more susceptible to damage from:

- Broken glass.
- Falling panels.
- Collapsing walkways and stairways.

Age, type of construction, and type of disaster are major factors in potential damage to detached homes and garages.

- Homes built before 1940 generally were not bolted to the foundation, making them subject to being shaken, blown, or floated off their foundations.
- Older homes constructed of unreinforced brick are less stable than newer construction.

Remember that:

- Tornado and hurricane damage to single homes can range from little damage to total destruction.
- Following an event in which a structure has been damaged, there is a threat of additional damage, such as fire from ruptured gas lines.

**STRUCTURAL AND NONSTRUCTURAL HAZARDS (CONTINUED)**

Mobile homes are most susceptible to damage because they are easily displaced. When displacement occurs, structural integrity becomes questionable, and utility connections are easily damaged, increasing the risk of fire and electric shock.

Malls, sports arenas, airports, places of worship, and other places with long roof spans also may pose hazards in some types of disasters. For example:

- Strip shopping centers pose a threat from collapse and broken glass.
- Warehouse-type structures may also collapse.

There is also risk in all types of structures from nonstructural hazards.

**NONSTRUCTURAL HAZARDS**

Everyone has hazards in their homes or workplaces. Fixtures and items within a home, garage, or workplace can pose a hazard during or after a disaster. Some of the hazards include:

- Gas line ruptures from water heaters or ranges displaced by shaking, water, or wind.
- Damage from falling books, dishes, or other cabinet contents.
- Risk of injury or electric shock from displaced appliances and office equipment.
- Fire from faulty wiring, overloaded plugs, frayed electrical cords.

There are relatively simple measures that individuals can take to alleviate many home and workplace hazards.

---

**HAZARD MITIGATION**

It is important to become informed on the probable impacts of likely events, including the potential for terrorist activity. The more information you have, the better you will be able to plan adequately and respond reasonably.

Regardless of the event or the amount of warning offered, there are safety precautions that you can take to reduce or prevent injury. This section will deal with measures to ensure personal safety.

The next section will address:

- Home and worksite preparedness.
- Community preparedness.

**HAZARD MITIGATION (CONTINUED)**

**PERSONAL SAFETY**

The appropriate personal safety measures are determined by:

- The type of event.
- The amount of warning that you have.
- Whether you are inside, outside, or driving.

Protecting yourself during a disaster requires planning. There are measures you should take to prevent or minimize the damage caused by most hazards. These measures can be taken long before a disaster occurs, during the time of the disaster, and after the disaster has occurred.

**HOME AND WORKPLACE PREPAREDNESS**

Preparedness is the key to survival in a disaster. Individuals, families, and building managers can take steps that will help minimize structural and nonstructural hazards, facilitate escape, and promote survival during the period immediately following the event.

---

**HOME AND WORKPLACE PREPAREDNESS**

Home and worksite preparedness includes:

- Structural and nonstructural hazard mitigation.
- Individual preparations, such as:
  - Assembling a disaster supply kit.
  - Developing a disaster plan.
  - Developing a safe room in a secure area of the home (in case authorities ask you to stay indoors).

## COMMUNITY EMERGENCY RESPONSE TEAM

### UNIT 1: DISASTER PREPAREDNESS

#### HOME AND WORKPLACE PREPAREDNESS (CONTINUED)

##### STRUCTURAL AND NONSTRUCTURAL MITIGATION

##### Precautions Against Structural and Nonstructural Hazards

Type Of Hazard	Sample Precautions
Structural	<ul style="list-style-type: none"><li>▪ Bolt older houses to the foundation.</li><li>▪ Strap propane tanks.</li><li>▪ Raise utilities (above the level of flood risk).</li><li>▪ Strap mobile homes to their concrete pads.</li><li>▪ Ask a professional to check the foundation, roof connectors, chimney, etc.</li></ul>
Nonstructural	<ul style="list-style-type: none"><li>▪ Anchor such furniture as bookshelves, hutches, and grandfather clocks to the wall.</li><li>▪ Secure appliances and office equipment in place with industrial-strength Velcro®.</li><li>▪ Secure cabinet doors with childproof fasteners.</li><li>▪ Locate and label shutoffs for gas, electricity, and water before disasters occur. After a disaster, shut off the utilities as needed to prevent fires and other risks. Store a shutoff wrench where it will be immediately available.</li><li>▪ Secure water heaters to the wall to safeguard against a ruptured gas line or loose electrical wires.</li></ul>

HOME AND WORKPLACE PREPAREDNESS (CONTINUED)

Electrical Shut-Offs

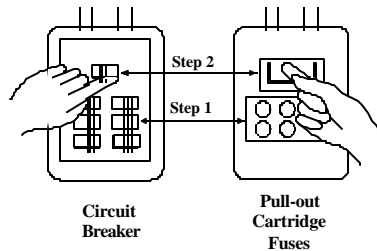

Water Shut-Off

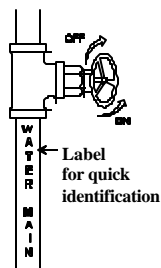

Gas Meter And Shut-Off Valve

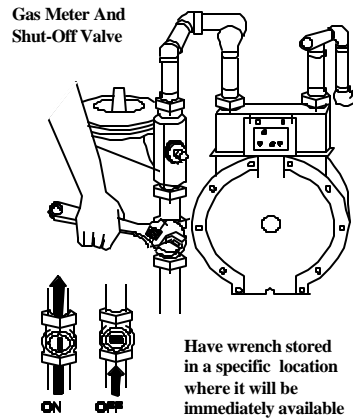

Utility Shutoffs

**Utility Shutoffs: Electrical, Water, Gas.** The electrical shutoff procedure shows both a circuit box and a fuse box and shows two steps. Step 1 is to turn off all individual breakers (or unscrew fuses). Step 2 is to shut off the main circuit (or main fuse switch). The water shut-off indicates a clockwise turn of the valve to shut off and a counter-clockwise turn to turn on. The gas meter shut-off diagram indicates the shut-off valve location on the pipe that comes out of the ground. To turn off the valve, use a wrench to turn the valve clockwise one-quarter turn.

**HOME AND WORKPLACE PREPAREDNESS (CONTINUED)**

Different nonstructural hazards pose different threats, depending on the disaster. Provide a few examples of preventive measures, and refer the participants to FEMA's *Talking About Disasters* website for more in-depth discussion: [www.fema.gov/rrr/talkdiz/](http://www.fema.gov/rrr/talkdiz/).

- Home Fires: Make sure that burglar bars and locks on outside window entries are easy to open.
- Landslides/Mudslides: Install flexible pipe fittings to avoid gas or water leaks. Flexible fittings are more resistant to breakage.
- Wildfires:
  - Avoid using wooden shakes and shingles for roofing.
  - Clear all flammable vegetation at least 30 feet from the home. Remove vines from the walls of the home.
  - Place propane tanks at least 30 feet from the home or other structures.
  - Stack firewood at least 30 feet away and uphill from the home.

**DEVELOPING A DISASTER PLAN**

A disaster plan can mean the difference between life and death. For example:

- How will you escape your home?
- Where will you meet family members?
- What route will you take out of your neighborhood if evacuation becomes necessary? Do you have an alternate route in case your route is blocked or otherwise impassable?
- What will you take with you?
- Where will you go?
- What will you need to shelter in place? Do you have those items (or enough of those items)?

You should play the "What if?" game (What will I do if this happens?) for every hazard that presents a high risk to the community. Then begin within the home and work outward to answer each of the questions above.

**HOME AND WORKPLACE PREPAREDNESS (CONTINUED)**

The answers to these questions may be different depending on the hazard, and you probably will not be able to plan for every event that could happen. By playing “What if?” with high-risk hazards, you will be better prepared for any hazard that might strike.

**CREATING A FAMILY DISASTER PLAN****To get started . . .**

- Contact your local emergency management office and your local chapter of The American Red Cross.
  - Find out which disasters are most likely to happen in your community.
  - Ask how you would be warned.
  - Find out how to prepare for each type of disaster.
- Meet with your family.
  - Discuss the types of disasters that could occur.
  - Explain how to prepare and respond.
  - Discuss what to do if advised to evacuate.
  - Practice what you have discussed.
- Plan how your family will stay in contact if separated by disaster.
  - Pick two meeting places:
    - ▼ A location a safe distance from your home in case of fire.
    - ▼ A place outside your neighborhood in case you can't return home.
  - Choose an out-of-state friend as a “check-in contact” for everyone to call.
- Complete the following steps.
  - Post emergency telephone numbers by every phone.
  - Show responsible family members how and when to shut off water, gas, and electricity at main switches.
  - Install a smoke alarm on each level of your home, especially near bedrooms; test them monthly and change the batteries two times each year. (Change batteries when you change your clocks in the spring and fall.)

**HOME AND WORKPLACE PREPAREDNESS (CONTINUED)**

- Contact your local fire department to learn about home fire hazards.
  - Learn first aid and CPR. Contact your local chapter of The American Red Cross for information and training.
- Meet with your neighbors.
  - Plan how the neighborhood could work together after a disaster. Know your neighbors' skills (medical, technical).
  - Consider how you could help neighbors who have special needs, such as elderly or disabled persons.
  - Make plans for child care in case parents can't get home.

**ESCAPE PLANNING**

Develop an escape plan that provides for escape from every room. As part of your escape plan:

- Consider the needs of children and physically challenged individuals.
- Inform all family members or office coworkers of the plan.
- Run practice escape drills.

An example of an escape plan is shown in the figure that follows.

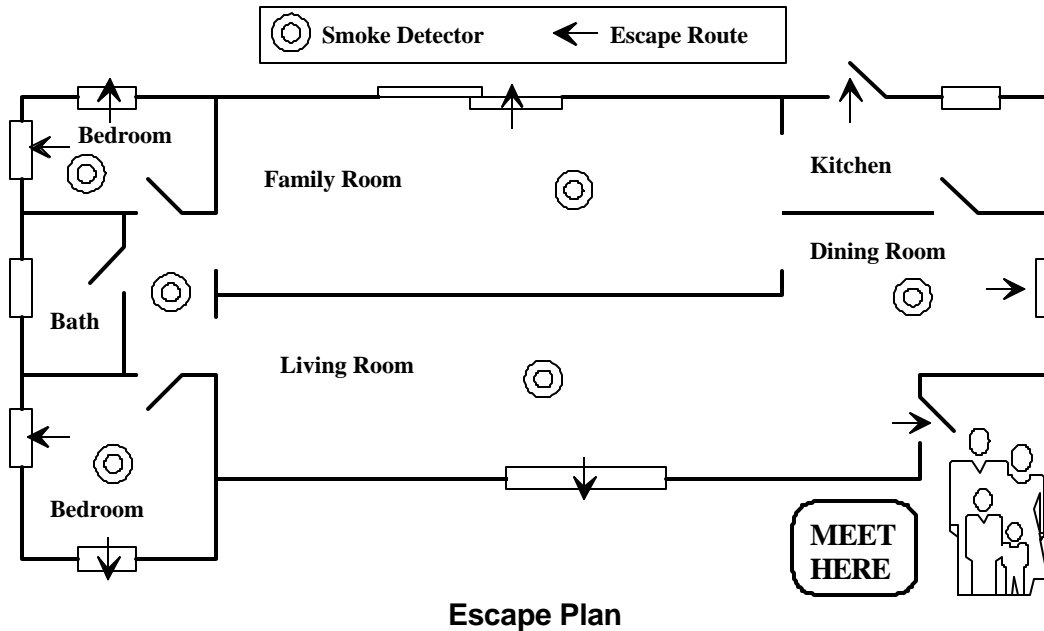

**Sample family escape plan with arrows showing an escape route from every room in the home and a family meeting place outside the home.**



**HOME AND WORKPLACE PREPAREDNESS (CONTINUED)**

The disaster supplies included on this list is fairly complete, and you should determine the supplies that you will need for evacuation, those that you will need to shelter in place, and those that you will need for both.

- Evacuation-only supplies and supplies (e.g., prescription medications) that are required for evacuation and shelter in place should be stored where they can be accessed quickly in an evacuation situation.
- Shelter-in-place-only supplies (e.g., 3 days of water for each family member) should be stored in an accessible location within the home or workplace.

**Assembling and Storing an Disaster Supply Kit**

You can cope best by preparing for disaster before it strikes. One way to prepare is by assembling a Disaster Supply Kit. After disaster strikes, you won't have time to shop or search for supplies. But if you've gathered supplies in advance, you and your family can endure an evacuation or home confinement.

**To Prepare Your Kit**

1. Review the checklist on the next few pages (from FEMA L-189, ARC 4463, Your Family Disaster Supplies Kit).
2. Gather the supplies from the list.
3. Place the supplies you're apt to need for an evacuation in an easy-to-carry container. These supplies are listed with an asterisk (\*).

**Water**

Store water in plastic containers such as soft drink bottles. Avoid using containers that will decompose or break, such as milk cartons or glass bottles. A normally active person needs to drink at least two quarts of water each day. Hot environments and intense physical activity can double that requirement. Children, nursing mothers, and ill people will need more.

- Store 1 gallon of water per person per day (2 quarts for drinking, 2 quarts for food preparation/sanitation.)\*
- Keep at least a 3-day supply of water for each person in your household.

If you have questions about the quality of the water, purify it before drinking. You can heat water to a rolling boil for 1 minute or use commercial purification tablets to purify the water. You can also use household liquid chlorine bleach if it is pure, unscented, 5.25% sodium hypochlorite. To purify water, use the table below as a guide:

**Ratios for Purifying Water with Bleach**

<b>Water Quantity</b>	<b>Bleach Added</b>
1 Quart	4 Drops
1 Gallon	16 Drops
5 Gallons	1 Teaspoon

**Ratios for purifying water with bleach: Water quantity and bleach added**

After adding bleach, shake or stir the water container and let it stand 30 minutes before drinking.

**Assembling and Storing an Disaster Supply Kit**

**Food**

Store at least a 3-day supply of nonperishable food. Select foods that require no refrigeration, preparation, or cooking and little or no water. If you must heat food, pack a can of Sterno®. Select food items that are compact and lightweight. Include a selection of the following foods in your disaster supply kit:

- Ready-to-eat canned meats, fruits, and vegetables
- Canned juices, milk, soup (if powdered, store extra water)
- Staples—sugar, salt, pepper
- High-energy foods—peanut butter, jelly, crackers, granola bars, trail mix
- Foods for infants, elderly persons, or persons on special diets
- Comfort/stress foods—cookies, hard candy, sweetened cereals, lollipops, instant coffee, tea bags

**Kitchen Items**

- Manual can opener
- Mess kits or paper cups, plates, and plastic utensils
- All-purpose knife
- Household liquid bleach to treat drinking water
- Sugar, salt, pepper
- Aluminum foil and plastic wrap
- Re-sealing plastic bags
- If food must be cooked, small cooking stove and a can of cooking fuel

**Assembling and Storing an Disaster Supply Kit**

**First Aid Kit\***

Assemble a first aid kit for your home and one for each car. A first aid kit should include:

- First aid manual
- Sterile adhesive bandages in assorted sizes
- 2-inch sterile gauze pads (4-6)
- 4-inch sterile gauze pads (4-6)
- Hypoallergenic adhesive tape
- Triangular bandages (3)
- Needle
- Moistened towelettes
- Antibacterial ointment
- Thermometer
- Tongue blades (2)
- Tube of petroleum jelly or other lubricant
- Assorted sizes of safety pins
- Cleaning agent/soap
- Latex gloves (2 pairs)
- Petroleum jelly
- Cotton balls
- Sunscreen
- 2-inch sterile roller bandages (3 rolls)
- 3-inch sterile roller bandages (3 rolls)
- Scissors
- Tweezers

**Nonprescription Drugs**

- Aspirin or nonaspirin pain reliever
- Antidiarrhea medication
- Antacid (for stomach upset)
- Syrup of Ipecac (used to induce vomiting if advised by the Poison Control Center)
- Laxative
- Vitamins
- Activated charcoal (used if advised by the Poison Control Center)

**Tools and Supplies**

- Mess kits, or paper cups, plates and plastic utensils\*
- Emergency preparedness manual\*
- Battery-operated radio and extra batteries\*
- Flashlight and extra batteries\*
- Fire extinguisher: small canister, ABC type
- Tube tent
- Pliers
- Duct tape
- Compass
- Matches in a waterproof container
- Aluminum foil
- Plastic storage containers
- Signal flare(s)
- Paper, pencil
- Needles, thread
- Work gloves
- Medicine dropper
- Shutoff wrench, to turn off household gas and water
- Whistle
- Plastic sheeting

**Sanitation**

- Toilet paper, towelettes\*
- Soap, liquid detergent\*
- Feminine supplies\*
- Personal hygiene items\*
- Plastic garbage bags, ties (for personal sanitation uses)
- Plastic bucket with tight lid
- Disinfectant
- Household chlorine bleach

**Assembling and Storing an Disaster Supply Kit**

**Clothing and Bedding**

Include at least one complete change of clothing and footwear per person.

- Sturdy shoes or work boots\*
- Rain gear\*
- Blankets or sleeping bags\*
- Hat and gloves\*
- Thermal underwear\*
- Sunglasses\*

**Household Documents and Contact Numbers**

- Personal identification, cash (including change) or traveler's checks, and a credit card
- Copies of important documents: birth certificates, marriage certificate, driver's license, social security cards, passport, wills, deeds, inventory of household goods, insurance papers, immunizations records, bank and credit card account numbers, stocks and bonds. Be sure to store these in a watertight container.
- Emergency contact list and phone numbers
- Map of the area and phone numbers of places you could go
- An extra set of car keys and house keys

**Special Items**

Remember family members with special needs, such as infants and elderly or disabled persons.

**For Baby\***

- Formula
- Diapers
- Bottles
- Powdered milk
- Medications

**For Adults\***

- Heart and high blood pressure medication
- Insulin
- Prescription drugs
- Denture needs
- Contact lenses and supplies
- Extra eye glasses

- Entertainment—games and books
- Important Family Documents—keep these records in a waterproof, portable container
- Will, insurance policies, contracts, deeds, stocks and bonds
- Passports, social security cards, immunization records
- Bank account numbers
- Credit card account numbers and companies
- Inventory of valuable household goods
- Important telephone numbers

\*Items marked with an asterisk are recommended for evacuation.

**HOME AND WORKPLACE PREPAREDNESS (CONTINUED)****EVACUATION OR SHELTER-IN-PLACE?**

Depending on the hazard and situation, the decision of whether to evacuate or shelter-in-place is not always easy. If time and location allow, you should listen to the Emergency Alert System (EAS) for instructions from emergency management professionals who are evaluating the situation.

Learn the evacuation and sheltering in place procedures for the hazards in your area.

---

**COMMUNITY PREPAREDNESS**

Citizen preparedness will be less effective if the community isn't prepared. Representatives of all agencies that have a role in response work together to organize their agencies' activities before an emergency or disaster. The product of their efforts is called an Emergency Operations Plan, or EOP.

**THE EMERGENCY OPERATIONS PLAN (EOP)**

The EOP is a document that:

- Assigns responsibility to organizations and individuals for carrying out specific actions at projected times and places in an emergency that exceeds the capability or routine responsibility of any one agency (e.g., the fire department).
- Sets forth lines of authority and organizational relationships, and shows how all actions will be coordinated.
- Describes how people and property will be protected in emergencies and disasters.
- Identifies personnel, equipment, facilities, supplies, and other resources available—within the jurisdiction or by agreement with other jurisdictions—for use during response and recovery operations.

In short, the EOP describes how the community will do business in an emergency.

**COMMUNITY PREPAREDNESS (CONTINUED)****COMMUNITY PREPAREDNESS AND CERTS**

Communities also prepare for disasters when they establish Community Emergency Response Teams (CERTs) to respond in their area immediately after a disaster when response resources are overwhelmed or delayed. CERTs based on their standard operating procedures develop by the sponsoring agency:

- Assist first responders.
- Assume many of the same functions as response personnel:
  - Fire safety
  - Light search and rescue
  - Medical operations

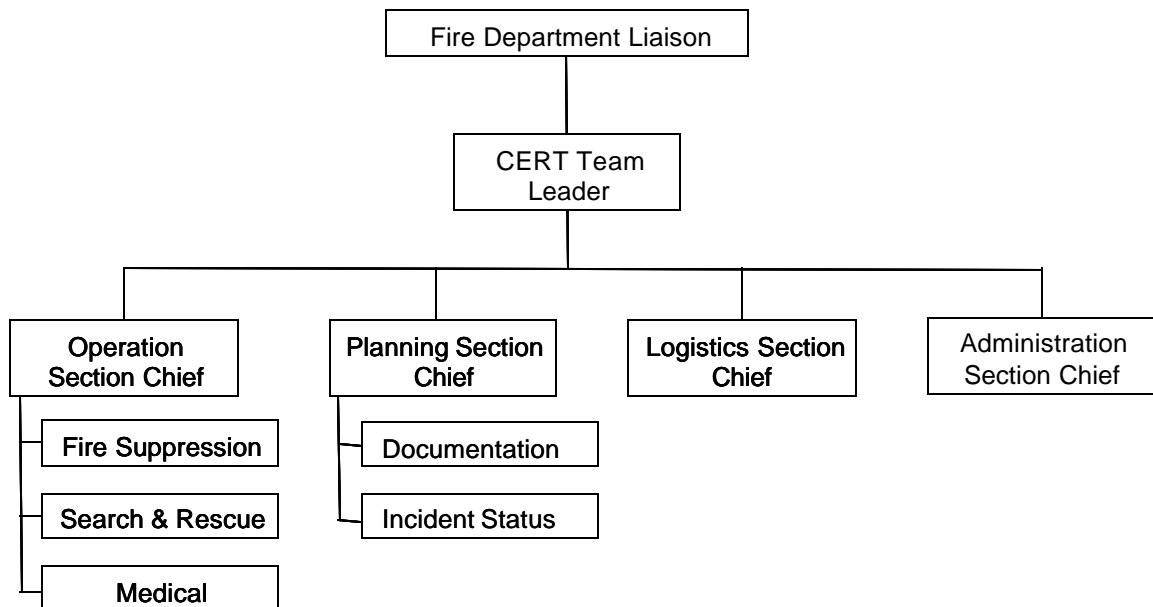
**CERT Organization**

Showing the Fire Department Liaison at the top. Underneath is the CERT Team Leader who directs the activities of four sections: Operations, Planning, Logistics, and Administration. Underneath the Operations Section are three response teams: Fire Suppression Search and Rescue, and Medical. Underneath the Planning Section are two sections: Documentation and Incident Status.

No matter which function CERT members are assigned to, effective CERTs require teamwork.

---

---

**COMMUNITY EMERGENCY RESPONSE TEAM****UNIT 1: DISASTER PREPAREDNESS**

---

**PROTECTION FOR DISASTER WORKERS**

As volunteers, CERT members functioning in emergency services are generally protected by “Good Samaritan” laws that protect people who provide emergency care in a prudent and reasonable manner.

In a disaster, CERT members are also protected by the Volunteer Protection Act of 1997, a Federal law that protects volunteers from liability as long as they are acting in accordance with the training that they have received.

People who volunteer their services during a disaster are generally protected by Federal, State, and/or local laws. Most states have “Good Samaritan” laws that protect people who provide emergency care *in a prudent and reasonable manner* to ill or injured persons. Other city, county, or State laws may also apply. Your instructor will provide information about laws that apply in your area. Record the key points below for future reference.

Applicable Laws	Key Points



**UNIT SUMMARY**

CERTs are among a variety of agencies and personnel who cooperate to provide assistance in the aftermath of a disaster. The keys to CERT effectiveness are in:

- Familiarity with the types of events that are high risk for the area and the types of damage that can occur as a result.
- Adequate preparation for each event and its aftermath.
- Training in the functional areas to which CERTs are assigned.
- Practice through refreshers and simulations.

CERTs have proven themselves invaluable in the areas in which they were tested. They can be invaluable in this community as well.

CERTs have become a key component of President Bush's Citizen Corps.

**HOMEWORK ASSIGNMENT**

The next unit will cover fire safety. Before the next session, you should:

1. Read and familiarize yourself with Unit 2: Fire Safety in the Participant Manual.
2. Bring a pair of leather gloves and safety goggles to use in the fire suppression unit, and to serve as a starting point for your disaster supply kits.
3. Begin food and water storage for at least 3 days for yourself and your families.
4. Establish an out-of-state contact.
5. Locate the utility shutoffs in your home.

Wear appropriate clothes to the next session (no shorts or open-toed shoes), because you will practice putting out a small fire with an extinguisher.

---



---

# UNIT 1: ADDITIONAL MATERIALS

---

---

---



---

**COMMUNITY EMERGENCY RESPONSE TEAM**

**UNIT 1: DISASTER PREPAREDNESS**

---

**COMMUNITY EMERGENCY RESPONSE TEAM CHECKLIST**

**Instructions:** This checklist will help guide you in the setup of your CERT as well as emergency preparedness at home.

<i>Personal Preparedness</i>	<i>If Completed Check</i>	<i>Date Checked</i>
▪ Food	Ž	
▪ Water	Ž	
▪ Out-of-State Phone Contact	Ž	
▪ Mitigation Measures		
• Water heater	Ž	
• Utilities	Ž	
• Cabinets, etc.	Ž	
• Other: _____	Ž	
<b>Team Organization</b>		
▪ Leadership		
• Team leader	Ž	
• Group leaders	Ž	
▪ Membership		
• Roster	Ž	
• Phone list	Ž	
• Skills inventory	Ž	
▪ Communications		
• Telephone tree	Ž	
• Newsletter	Ž	
• Amateur radio	Ž	
• Runners	Ž	

---

**COMMUNITY EMERGENCY RESPONSE TEAM****UNIT 1: DISASTER PREPAREDNESS**

---

**COMMUNITY EMERGENCY RESPONSE TEAM CHECKLIST (CONTINUED)**

<i>Team Organization</i>	<i>If Completed Check</i>	<i>Date Checked</i>
▪ Resources and Locations		
• Personnel	Ž	
• Equipment	Ž	
• Supplies	Ž	
• Response kits	Ž	
▪ Area Surveys		
• Evacuation plans		
• Staging area	Ž	
• Medical treatment area	Ž	
• Specific hazard areas	Ž	
• Area maps	Ž	
▪ Response Plan	Ž	
• Response criteria		
• Communications/notifications		
• Staging area/command post	Ž	
	Ž	
	Ž	
▪ Teamwork		
• Meetings	Ž	
• Drills and exercises	Ž	
• Training	Ž	
▼ First aid	Ž	
▼ CPR	Ž	
▼ Other: _____	Ž	
	Ž	

---

## COMMUNITY EMERGENCY RESPONSE TEAM

### UNIT 1: DISASTER PREPAREDNESS

#### RECOMMENDED CERT EQUIPMENT AND SUPPLIES

The following equipment and supplies are recommended as a minimum supply cache for all CERT teams. The equipment and supplies should be maintained at or near the team staging area.

<b><i>Equipment/Supply</i></b>	<b><i>Date Obtained</i></b>	<b><i>Quantity</i></b>	<b><i>Date Checked</i></b>
<ul style="list-style-type: none"><li>▪ Nylon/canvas bag with shoulder strap</li><li>▪ Water (two canteens/bottles per Search and Rescue team)</li><li>▪ Dehydrated foods</li><li>▪ Water purification tablets</li><li>▪ Work gloves (leather)</li><li>▪ Goggles</li><li>▪ Dust masks</li><li>▪ Flashlight or miner's lamp</li><li>▪ Batteries and extra bulbs</li><li>▪ Secondary flashlight or light sticks</li><li>▪ Utility knife</li><li>▪ Note pads</li><li>▪ Markers:<ul style="list-style-type: none"><li>• Thin-point</li><li>• Thick-point</li></ul></li><li>▪ Pens</li><li>▪ Duct tape</li><li>▪ Masking tape (2-inch)</li><li>▪ Scissors</li></ul>			

**COMMUNITY EMERGENCY RESPONSE TEAM**

**UNIT 1: DISASTER PREPAREDNESS**

**RECOMMENDED CERT EQUIPMENT AND SUPPLIES (CONTINUED)**

	<i>Date Obtained</i>	<i>Quantity</i>	<i>Date Checked</i>
<ul style="list-style-type: none"><li>▪ Crescent wrench</li><li>▪ First aid pouch containing:<ul style="list-style-type: none"><li>• 4 x 4 gauze dressings (6)</li><li>• Abdominal pads (4)</li><li>• Triangular bandages (4)</li><li>• Band-Aids</li><li>• Roller bandage</li></ul></li></ul>			



---

# UNIT 2: FIRE SAFETY

---

---

## In this unit you will learn about:

- **Fire Chemistry:** How fire occurs, classes of fire, and choosing the correct means to extinguish each type of fire.
- **Fire Hazards:** Potential fire hazards in the home and workplace, and fire prevention strategies.
- **Fire Safety:** How to evaluate fires, assess firefighting resources, and determine a course of action.
- **Portable Fire Extinguishers:** Types of portable fire extinguishers and how to operate them.
- **Fire Suppression Safety:** How to decide if you should attempt to extinguish a fire; how to approach and extinguish a fire safely.
- **Teamwork:** The importance of working with a buddy.
- **Hazardous Materials:** How to identify potentially dangerous materials in storage or in transit.



UNIT 2: FIRE SAFETY

---

**INTRODUCTION AND UNIT OVERVIEW**

During and immediately following a severe emergency, the first priorities of professional fire services are life safety and extinguishing *major* fires. They may be hampered by impassable roads, inadequate water supply, weather conditions, burning material, and inadequate resources.

CERTs play a very important role in fire safety by:

- Extinguishing small fires before they become major fires. This unit will provide training on how to use an extinguisher to put out small fires—and how to recognize when a fire is too big to handle.
- Preventing additional fires by removing fuel sources. This unit will also describe how to ensure that a fire, once extinguished, is completely extinguished.
- Shutting off utilities, when necessary and safe to do so.
- Assisting with evacuations where necessary. When a fire is beyond the ability of CERTs to extinguish, CERT members need to protect life safety by evacuating the area, when necessary, and establishing a perimeter.

CERT members help in fire-related emergencies when professional responders (paid and volunteer) are delayed. When responding, CERT members should keep in mind the following CERT standards:

- Rescuer safety is always the number one priority. Therefore, CERT members always:
  - Work with a buddy.
  - Wear safety equipment (gloves, helmet, goggles, mask, and boots).
- The CERT goal is to do the greatest good for the greatest number.

**INTRODUCTION AND UNIT OVERVIEW (CONTINUED)****UNIT OBJECTIVES**

At the end of this unit, you should be able to:

- Explain the role that CERTs play in fire safety.
- Identify and reduce potential fire risks in the home and workplace.
- Conduct a basic sizeup for a fire emergency.
- Understand minimum safety precautions, including:
  - Safety equipment.
  - Utility control.
  - Buddy system.
  - Back-up teams.
- Identify locations of hazardous materials in the community and the home, and reduce the risk from hazardous materials in the home.
- Extinguish small fires using a fire extinguisher.

The unit will provide you with the knowledge and skills that you will need to reduce or eliminate fire hazards and extinguish small fires. The areas that you will learn about include:

- How fires start and what keeps them burning.
  - Identification of fire hazards in the home, neighborhood, and workplace.
  - How to conduct a fire assessment, or sizeup.
  - The main firefighting resources that are available to CERTs and how to use them.
  - Procedures for safe firefighting.
  - Hazardous materials identification.
-

FIRE CHEMISTRY

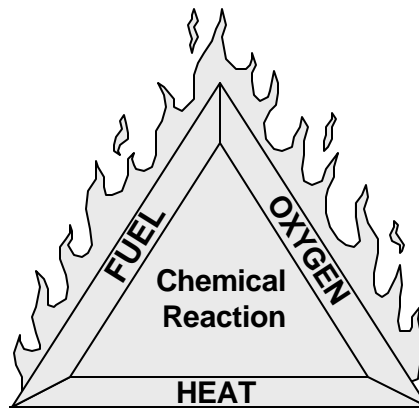

Fire Triangle

**Fire Triangle:** Fuel, oxygen, and heat create a chemical reaction, which causes fire.

Fire requires three elements to exist:

- Heat: Heat is required to elevate the temperature of a material to its ignition point.
- Fuel: The fuel for a fire may be a solid, liquid, or gas. The type and quantity of the fuel will determine which method should be used to extinguish the fire.
- Oxygen: Most fires will burn vigorously in any atmosphere of at least 20 percent oxygen. Without oxygen, most fuels could be heated until entirely vaporized, yet would not burn.

Working together, these three elements, called the *fire triangle*, create a chemical exothermic reaction, which is fire.

If any of these elements is missing or if any is taken away, fire will not occur or will extinguish.

**FIRE CHEMISTRY (CONTINUED)**

To aid in extinguishing fires, fires are categorized into classes based on the type of fuel that is burning:

- Class A Fires: Ordinary combustibles such as paper, cloth, wood, rubber, and many plastics
- Class B Fires: Flammable liquids (e.g., oils, gasoline) and combustible liquids (e.g., charcoal lighter fluid, kerosene) (These fuels burn only at the surface because oxygen cannot penetrate the depth of the fluid. Only the vapor burns when ignited.)
- Class C Fires: Energized electrical equipment (e.g., wiring, motors). (When the electricity is turned off, the fire becomes a class A fire.)
- Class D Fires: Combustible metals (e.g., aluminum, magnesium, titanium)

It is extremely important to identify the type of fuel to select the correct method and agent for extinguishing the fire.

---

**REDUCING FIRE HAZARDS IN THE HOME AND WORKPLACE**

Part of CERT planning is to identify hazards in the area that would affect residents in an emergency. This information is important to professional responders when they arrive on scene.

Each of us has some type of fire hazard in our home or workplace. Most of these hazards fall into three categories:

- Electrical hazards
- Natural gas hazards
- Flammable or combustible liquids

Homes and workplaces can and do have other hazards, including incompatible materials stored in close proximity to each other.

Simple fire prevention measures will go far in reducing the likelihood of fires:

- First, *locate* potential sources of ignition.
- Then, do what you can to *reduce or eliminate* the hazards.

**REDUCING FIRE HAZARDS IN THE HOME AND WORKPLACE (CONTINUED)**

**ELECTRICAL HAZARDS**

Simple ways that common electrical hazards can be reduced or eliminated include:

- Avoid the “electrical octopus.” Eliminate tangles of electrical cords. Don’t overload electrical outlets. Don’t plug power strips into other power strips.
- Don’t run electrical cords under carpets.
- Replace broken or frayed cords immediately.
- Maintain electrical appliances properly. Repair or replace malfunctioning appliances.

Emergencies sometimes occur despite our best efforts. In the event of an electrical emergency:

- Know where the power shutoffs for electrical appliances are.
- Know where the power shutoff for circuit breakers or fuses is and how to shut off the power.
- Unscrew individual fuses or switch off smaller breakers first, then pull the main switch or breaker.
- When turning the power back on, turn on the main switch or breaker first, then screw in the fuses or switch on the smaller breakers.

You should not enter a flooded basement to shut off the electrical supply, because water conducts electricity.

REDUCING FIRE HAZARDS IN THE HOME AND WORKPLACE (CONTINUED)

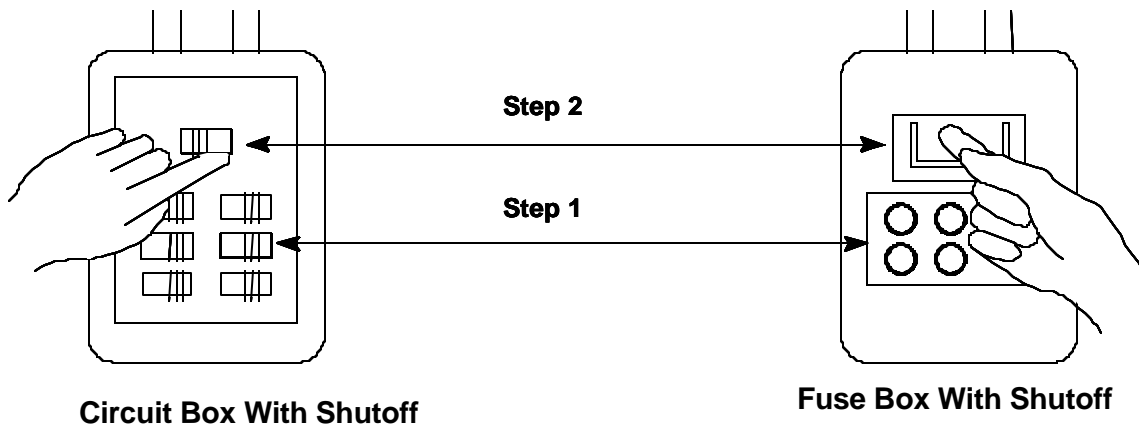

**Circuit box showing shutoff steps.**  
Step 1: Shut off individual breakers.  
Step 2: Shut off main breaker.

**Fuse box showing shutoff steps.**  
Step 1: Pull out individual fuses.  
Step 2: Pull out main fuse.

**NATURAL GAS HAZARDS**

Natural gas presents two types of hazards. It is an:

- Asphyxiant that robs the body of oxygen.
- Explosive that can easily ignite.

To reduce natural gas hazards:

- Install a natural gas detector near the furnace and hot water tank. Test the detector monthly to ensure that it works.
- Locate and label the gas shutoff valve(s). (There may be multiple valves inside a home in addition to the main shutoff.) Know how to shut off the gas and have the proper tool for shutting off the gas handy.



REDUCING FIRE HAZARDS IN HOME AND WORKPLACE (CONTINUED)

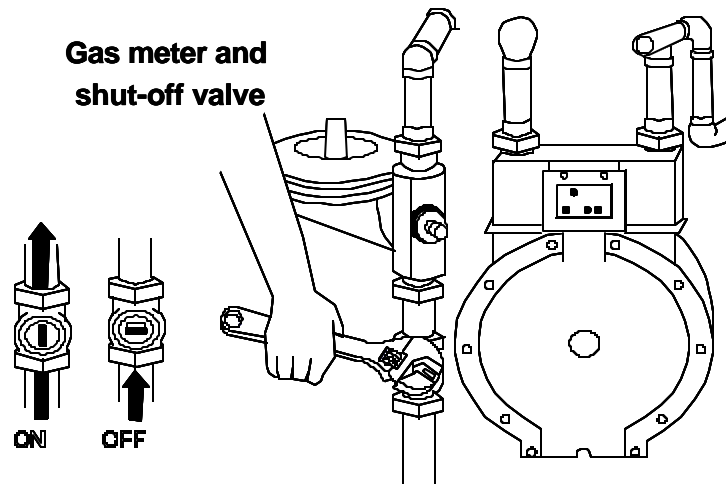

Natural Gas Meter With Shutoff

The gas meter shut-off diagram indicates the shut-off valve location on the pipe that comes out of the ground. To turn off the valve, use a wrench to turn the valve clockwise one-quarter turn.

**REDUCING FIRE HAZARDS IN HOME AND WORKPLACE (CONTINUED)**

In a disaster, if you smell gas, leave the building immediately. If there is a fire, turn off the gas from outside the building. After service is turned off, however, it can be restored only by a trained technician.

Never enter the basement of a structure that is on fire to turn off any utility.

**FLAMMABLE LIQUID HAZARDS**

To reduce hazards from flammable liquids:

- Read labels to identify flammable products.
- Store them properly, using the L.I.E.S. method covered in Unit 1.

You should extinguish a flammable liquid using a portable fire extinguisher rated for that class of fire. Ratings for portable extinguishers will be addressed later in this unit.

---

### CERT SIZEUP

CERT sizeup is a continual data-gathering process that will dictate whether to attempt fire suppression and planning for extinguishing the fire.

CERT sizeup answers the questions:

- Can my buddy and I fight the fire safely?
- Do my buddy and I have the right equipment?
- Are there other hazards?
- Is the building structurally damaged?
- Can my buddy and I escape?

Sizeup is a continual nine-step process that enables first responders to make decisions and respond appropriately in the areas of greatest need.

The nine steps in sizeup are:

1. Gather facts. What has happened? How many people are involved (if you know)? What is the current situation?
2. Assess and communicate the damage. Take a lap around the building. Try to determine what has happened, what is happening now, and how bad things can really get.
3. Consider probabilities. What is likely to happen? What could happen through cascading events?
4. Assess your own situation. Are you in immediate danger? Have you been trained to handle the situation? Do you have the equipment that you need?
5. Establish priorities. Are lives at risk? Can you help? Remember, life safety is the first priority!
6. Make decisions. Base your decisions on the answers to Steps 1 through 3 and in accordance with the priorities that you established.
7. Develop plans of action. Develop a plan that will help you accomplish your priorities. Simple plans may be verbal, but more complex plans should always be written.

**CERT SIZEUP (CONTINUED)**

8. Take action. Execute your plan, documenting deviations and status changes so that you can report the situation accurately to first responders.
  9. Evaluate progress. At intervals, evaluate your progress in accomplishing the objectives in the plan of action to determine what is working and what changes you may have to make to stabilize the situation.
-

CERT FIRE SIZEUP CHECKLIST

	Yes	No
<b>Step 1: Gather Facts</b>		
<i>Time</i>		
▪ Does the time of day or week impact fire suppression efforts?	•	•
How?		
<i>Weather</i>		
▪ Will weather conditions impact your safety?	•	•
If yes, how will your safety be affected?		
▪ Will weather conditions affect the fire situation?	•	•
If yes, how will the fire situation be affected?		
<i>Type Of Construction</i>		
▪ What type(s) of structure(s) are involved?		
▪ What type(s) of construction are involved?		

**COMMUNITY EMERGENCY RESPONSE TEAM**

**UNIT 2: FIRE SAFETY**

**CERT FIRE SIZEUP CHECKLIST**

	<b>Yes</b>	<b>No</b>
<b>Step 1: Gather Facts (Continued)</b>		
<i>Occupancy</i>		
▪ Are the structures occupied?	•	•
If yes, how many people are likely to be affected?		
▪ Are there special considerations (e.g. children, elderly)?	•	•
<i>Hazards</i>		
▪ Are hazardous materials involved?	•	•
▪ Are any other types of hazards likely to be involved?	•	•
If yes, what other hazards?		
<b>Step 2: Assess and Communicate the Damage</b>		
▪ Take a lap around the building. Is the damage beyond the CERT team's capability?	•	•
▪ Are normal communication channels functioning?	•	•

CERT FIRE SIZEUP CHECKLIST

	Yes	No
<b>Step 3: Consider Probabilities</b>		
<i>Life Hazards</i>		
▪ Are there potentially life-threatening hazards? If yes, what are the hazards?	•	•
<i>Path of Fire</i>		
▪ Does the fire's path jeopardize other areas? If yes, what other areas may be jeopardized?	•	•
<i>Additional Damage</i>		
▪ Is there a high potential for more disaster activity that will impact personal safety? If yes, what are the known risks?	•	•
<b>Step 4: Assess Your Own Situation</b>		
▪ What resources are available with which you can suppress the fire?		
▪ What equipment is available?		

**COMMUNITY EMERGENCY RESPONSE TEAM**

**UNIT 2: FIRE SAFETY**

**CERT FIRE SIZEUP CHECKLIST**

	<b>Yes</b>	<b>No</b>
<b>Step 5: Establish Priorities</b>		
▪ Can fire suppression be <i>safely</i> attempted by CERT members?  <u>If no, do <i>not</i> attempt suppression.</u>	•	•
▪ Are there other, more pressing needs at the moment?  If yes, list.	•	•
<b>Step 6: Make Decisions</b>		
▪ Where will deployment of available resources do the most good while maintaining an adequate margin of safety?		
<b>Step 7: Develop a Plan of Action</b>		
▪ Determine how personnel and other resources should be deployed.		



CERT FIRE SIZEUP CHECKLIST

**Step 8: Take Action**

- Put the plans into effect.

**Step 9: Evaluate Progress**

- Continually size up the situation to identify changes in the:
  - Scope of the problem.
  - Safety risks.
  - Resource availability.
- Adjust strategies as required.

### **FIREFIGHTING RESOURCES**

The most common firefighting resources are:

- Portable fire extinguishers.
- Interior wet standpipes.

Portable fire extinguishers are invaluable for putting out small fires. A well-prepared home or workplace will have at least two portable fire extinguishers.

Interior wet standpipes are usually found in commercial and apartment buildings and consist of 100 feet of 1½-inch jacketed hose with a <sup>3</sup>/<sub>8</sub>-inch nozzle tip. They deliver up to 125 gallons of water per minute.

Always work in three-person teams when using an interior wet standpipe. One person handles the hose, another bleeds the air from the line, and the third person controls the water pressure.

There are also other firefighting resources available that are less common:

- In interior spaces, it is possible to *confine* a fire and restrict the spread of smoke and heat by closing doors to rooms and hallways.
- Other *creative* resources may also be available:
  - Swimming pool or spa water and buckets
  - Sand or dirt and shovels
  - A garden hose

The type of fuel that is burning will determine which resources to select to fight a fire.

### **EXTINGUISHER RATING AND LABELING**

Portable fire extinguishers must be rated and approved by the State Fire Marshal and Underwriters Laboratories. They are rated according to their effectiveness on the different classes of fire. Their strength and capability must also be labeled by the manufacturer.

The label contains vital information about the type(s) of fire for which the extinguisher is appropriate.

FIREFIGHTING RESOURCES (CONTINUED)

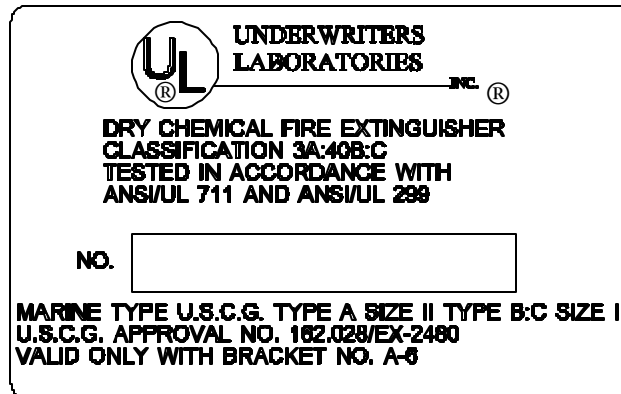

Manufacturer's Label

Sample Manufacturer's Label for a fire extinguisher, showing the Underwriters Laboratories Symbol at the top, the type and classification of fire extinguisher, testing procedures used, and serial number. At the bottom of the label is marine information, including the U.S. Coast Guard approval number.

TYPES OF FIRE EXTINGUISHERS

There are four types of extinguishers:









- Water
- Dry chemical
- Carbon dioxide
- Specialized fire extinguishers

**COMMUNITY EMERGENCY RESPONSE TEAM**

**UNIT 2: FIRE SAFETY**

**FIREFIGHTING RESOURCES (CONTINUED)**

**Fire Types, Extinguishing Agents, and Methods**

Fire Type	Extinguishing	
	Agent	Method
<b>Ordinary Solid Materials</b>  	Water	Removes heat
	Foam	Removes air and heat
	Dry chemical	Breaks chain reaction
<b>Flammable Liquids</b>  	Foam CO <sub>2</sub>	Removes air
	Dry chemical	Breaks chain reaction
<b>Electrical Equipment</b>  	CO <sub>2</sub>	Removes air
	Dry chemical	Breaks chain reaction
<b>Combustible Metals</b>  	Special agents	Usually remove air

**FIREFIGHTING RESOURCES (CONTINUED)**

Common characteristics of water extinguishers include:

- Capacity. Standard size is 2½ gallons.
- Range. Standard range is 30-40 feet.
- Pressure. Standard pressure is 110 pounds per square inch (psi).

Use extreme caution when using a water extinguisher to ensure that the water, which is under pressure, does not scatter lightweight materials and spread the fire.

Dry chemical extinguishers are also common.

- Dry chemical extinguishers have a sodium bicarbonate base and are effective on Class B and C fires.
- Multipurpose dry chemical extinguishers have a monoammonium phosphate base and are effective for Class A, B, and C fires.

Common characteristics of dry chemical extinguishers include:

- Capacity. Approximately 10-20 seconds discharge time.
- Range. Standard range is 8-12 feet.
- Pressure. Standard range is 175-250 psi.

While still in use, carbon dioxide and other specialized extinguishers are becoming less common.

**DECIDING TO USE A FIRE EXTINGUISHER**

There are a series of questions that you should ask yourself before attempting to fight a fire with a fire extinguisher.

If you answer “NO” to any of these questions, you should:

- Leave the building immediately.
- Shut all doors as you leave to slow the spread of the fire.

If all of the answers to the questions are “YES,” you may attempt to extinguish the fire. Even if you answer “YES” to all of the questions, but feel unable to extinguish the fire, you should leave immediately.

**FIREFIGHTING RESOURCES (CONTINUED)**

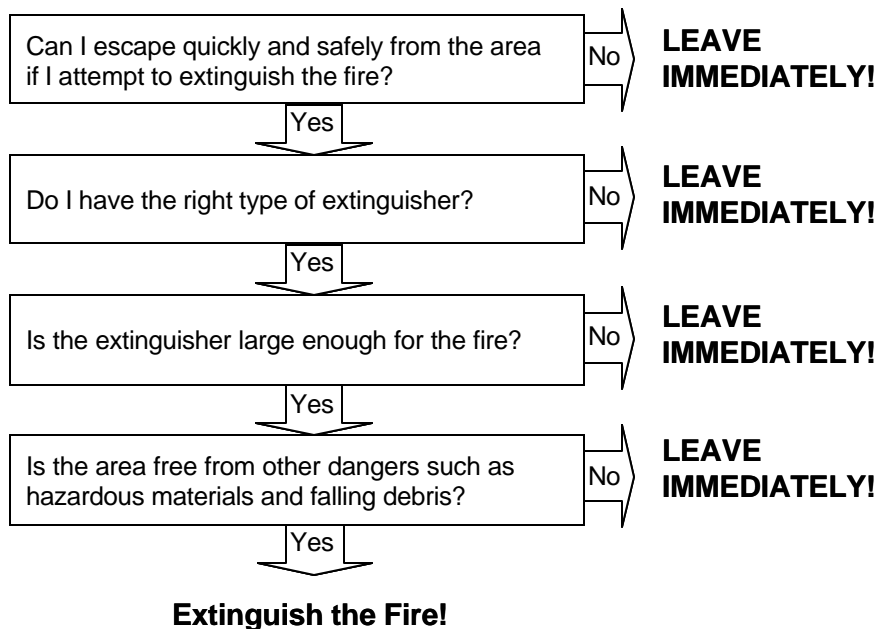

**Deciding to Use a Fire Extinguisher**

A flowchart illustrates the decisionmaking process for determining whether to use a fire extinguisher. The decision is based on four questions:

- Can I escape quickly and safely if I attempt to extinguish the fire?
- Do I have the right type of extinguisher?
- Is the extinguisher large enough for the fire?
- Is the area free from other dangers such as hazardous materials and fallen debris?

If the answer to all questions are “yes,” CERT members should attempt to extinguish the fire. If the answer to any questions are “no,” CERT members should leave.

**FIREFIGHTING RESOURCES (CONTINUED)**

**OPERATING A FIRE EXTINGUISHER**

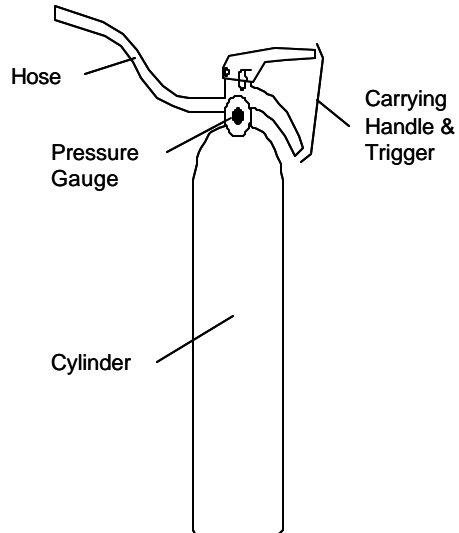

**Components of a Portable Fire Extinguisher**

**Components of a portable fire extinguisher: Hose, carrying handle and trigger, pressure gauge, cylinder**

A portable fire extinguisher includes four components:

- A pressure gauge
- A hose
- A cylinder
- A carrying handle with trigger

You should always operate portable fire extinguishers in an upright position.

The acronym for operating a fire extinguisher is P.A.S.S.:

- Pull
- Aim
- Squeeze
- Sweep

To ensure that the extinguisher is working properly, test it before approaching any fire.

FIREFIGHTING RESOURCES (CONTINUED)

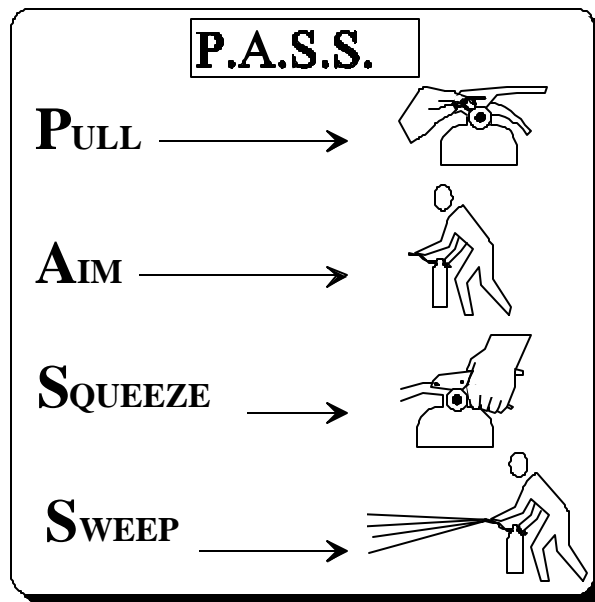

P.A.S.S

PASS: Pull, Aim, Squeeze, Sweep

Aim at the base of the fire.

---

**FIRE SUPPRESSION SAFETY**

As a CERT member, fire suppression will be one of your roles. However, even following a disaster, your personal safety must be your number one concern. You will be unable to help anyone if you are injured through careless sizeup or unsafe acts.

Fire suppression safety rules include:

- Use safety equipment at all times. Wear your helmet, goggles, dust mask, leather gloves, and heavy shoes. If you are not equipped to protect your personal safety, leave the building.
- Work with a buddy. Buddies serve an important purpose. They protect your safety. Don't ever try to fight a fire alone.
- Have a backup team, whenever possible. A backup team just makes good sense. A backup team can support your fire suppression efforts and can provide help if you need it.



**FIRE SUPPRESSION SAFETY (CONTINUED)**

- Always have two ways to exit the fire area. Fires spread much faster than you might think. Always have a backup escape plan in case your main escape route becomes blocked.
- Feel closed doors with the back of the hand, working from the bottom of the door up. Do not touch the door handle before feeling the door. If the door is hot, there is fire behind it. Do not enter! Opening the door will feed additional oxygen to the fire.
- Confine the fire, whenever possible, by keeping doors closed.
- Stay low to the ground. Smoke will naturally rise. Keeping low to the ground will provide you with fresher air to breathe.
- Maintain a safe distance. Remember the effective range of your fire extinguisher. Don't get closer than necessary to extinguish the fire.
- Overhaul the fire to be sure that it is extinguished—and stays extinguished.

What CERTs don't do when suppressing fires is as important as what they should do. DON'T:

- Get too close. Stay near the outer range of your extinguisher. If you feel the heat, you are too close.
  - Try to fight a fire alone. Remember that your first priority is your personal safety. Don't put yourself at risk.
  - Try to suppress large fires. Learn the capability of your equipment, and do not try to suppress a fire that is clearly too large for the equipment at hand (i.e., a fire that is larger than the combined ratings of available fire extinguishers).
  - Enter smoke-filled areas. Fire suppression in smoke-filled areas requires equipment that CERTs don't have.
-

### HAZARDOUS MATERIALS

Materials are considered hazardous if they have any of these characteristics listed below:

- Corrode other materials.
- Explode or are easily ignited.
- React strongly with water.
- Are unstable when exposed to heat or shock.
- Are otherwise toxic to humans, animals, or the environment.

Hazardous materials include, but are not limited to:

- Explosives.
- Flammable gases and liquids.
- Poisons and poisonous gases.
- Corrosives.
- Nonflammable gases.
- Oxidizers.
- Radioactive materials.

Knowledge that hazardous materials are present helps to protect CERT members' safety and is also valuable sizeup information for first responders.

Hazardous materials pose an ever-present danger. They are stored in all types of locations and are transported by a variety of means.

**HAZARDOUS MATERIALS (CONTINUED)**

**IDENTIFYING STORED HAZARDOUS MATERIALS**

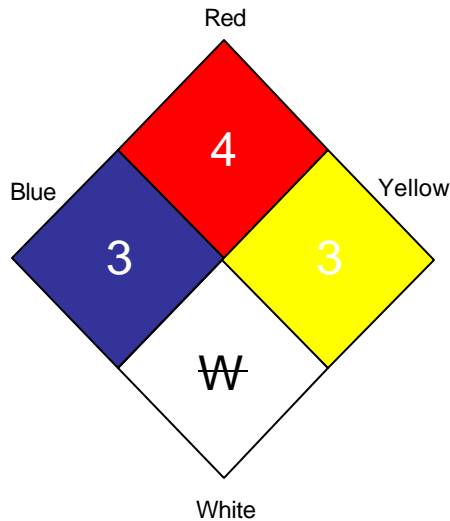

**National Fire Protection Association 704 Diamond**

The NFPA 704 Diamond, showing four quadrants and hazard ratings.

The figure above is an NFPA 704 Diamond—the identification system instituted by the National Fire Protection Association. The NFPA 704 Diamond is a concise system for identifying the hazards associated with specific materials. This placard would be found on a fixed facility.

The diamond is divided into four colored quadrants, each with a rating number inside of it, and that number indicates the degree of risk associated with the material. **The higher the number, the higher the risk!**

**NFPA 704 Diamond**

- The red quadrant describes the material's flammability.
- The blue quadrant indicates health hazard.
- The yellow quadrant indicates reactivity.

HAZARDOUS MATERIALS (CONTINUED)

Quadrant	Rating	Meaning
<b>White</b>	W	Indicates a material that shows unusual reactivity with water (i.e., should never be mixed with water or have water sprayed on it). <u>Magnesium metal</u> is an example of a material that is reactive to water.
	OX	Indicates a material that possesses oxidizing properties. <u>Ammonium nitrate</u> is an example of a material with oxidizing properties.
	ACID	Indicates that the material is an acid.
	ALK	Indicates that the material is a base.
	COR	Indicates that the material is corrosive.
		Indicates that the material is radioactive.

The numbers within the 704 Diamond are for professional firefighter use only. CERT members should consider these placards a “stop sign.” The only action CERT members should take when a facility is placarded with an NFPA 704 Diamond is to evacuate persons who are downwind, as necessary, to an uphill and upwind location.

HAZARDOUS MATERIALS (CONTINUED)

IDENTIFYING HAZARDOUS MATERIALS IN TRANSIT

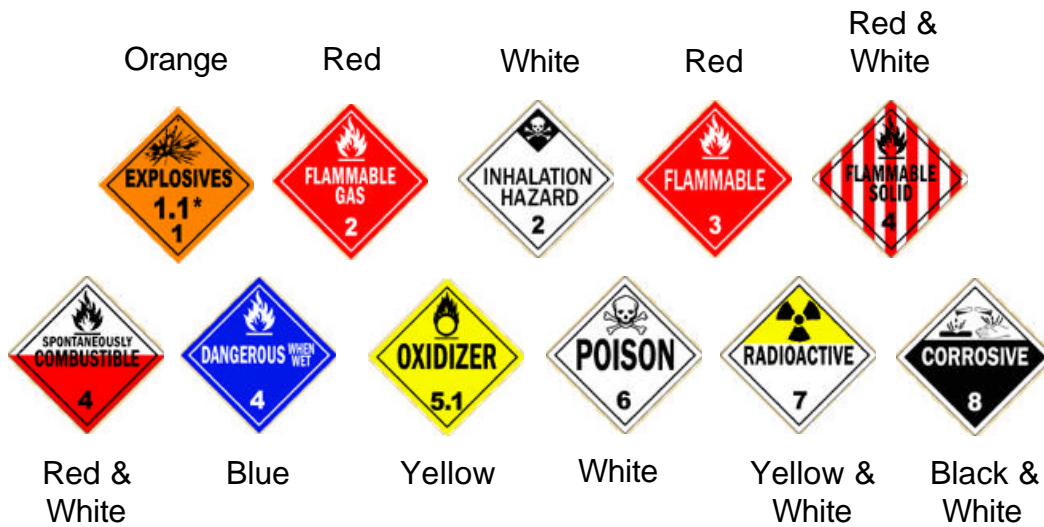

DOT Warning Placards

DOT Warning Placards: 1.1, Explosives; 2, Flammable Gas; 2, Inhalation Hazard; 3, Flammable; 4, Flammable Solid; 4, Spontaneously Combustible; 4, Dangerous When Wet; 5.1, Oxidizer; 6, Poison; 7, Radioactive; and 8, Corrosive.

These are Department of Transportation (DOT) placards. The DOT placard is one of three ways that hazardous materials are marked and identified while in transit. The other two ways are:

- The United Nations (UN) system.
- The North American (NA) warning placards.

HAZARDOUS MATERIALS (CONTINUED)

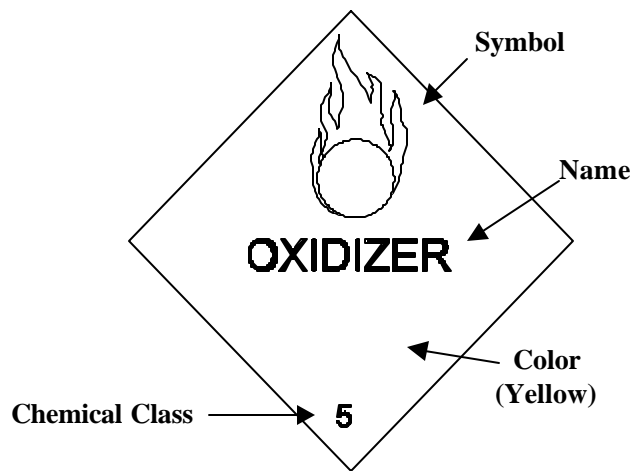

UN Placarding System

UN Placarding System, showing the hazard class in the bottom corner, the chemical category in the center, and the hazard symbol at the top of the placard.

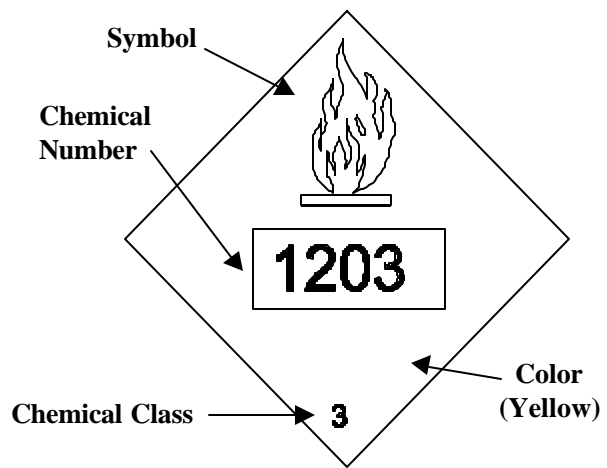

NA Numbering System

NA Numbering System, showing the hazard class in the bottom corner, the chemical number in a white box in the center, and the hazard symbol at the top of the placard.

These placards can be on any vehicle, not only tankers. Also:

- No placard is required for less than 1,000 pounds of many hazardous materials.
- Certain hazardous materials (e.g., anhydrous ammonia) are placarded as a nonflammable gas for domestic transport but as a flammable gas for international transport. (Anhydrous ammonia is a flammable gas!)
- Sometimes drivers forget to change the placard when they change their cargo. The group should use extreme caution when approaching any vehicle in an accident.

The DOT placard color is also significant.

You should always err on the side of safety. Do not assume that, because there is no placard, no hazardous materials are present.

- Talk to drivers or train crew members whenever possible.
- Treat any unknown situation as a hazardous materials incident.

Like the NFPA 704 Diamond, the DOT, UN, and NA placards should be a “stop sign” for CERT members.

**EXERCISE: SUPPRESSING SMALL FIRES**

**Purpose:** This exercise will provide you with experience in two key areas of fire suppression:

- Using a portable fire extinguisher to suppress a small fire
- Applying teamwork to fire suppression

**Instructions:** Follow the steps below to complete this exercise.

1. Work in two-person teams. Team members must communicate with each other. The emphasis is on safety and teamwork.
2. Each team member will be provided with a portable fire extinguisher.
3. Team Member 1 should assume the “ready” position, with pin pulled, extinguisher aimed and upright, approximately 20 to 25 feet from the fire.

**When ready to approach the fire, Team Member 1 should say, “Ready.” Team Member 2 should repeat, “Ready.”**

**As Team Member 1 begins to move forward, he or she should say, “Going in.” Team Member 2 should repeat the command and stay within reach of Team Member 1.**

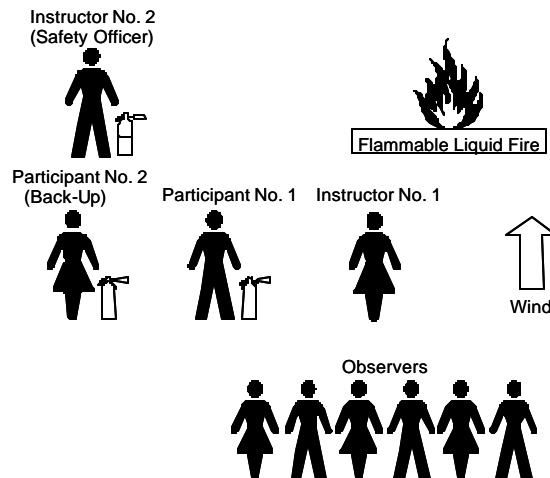

**Both team members should walk toward the fire. Team Member 1 should watch the fire and Team Member 2 should stay close to Team Member 1, keeping his or her hand on Team Member 1’s shoulder. Team Member 2’s job is to protect Team Member 1.**

4. Team Member 1 should approach the fire from the windward side (i.e., with the wind to the team member’s back). When approximately 10 feet from the fire, Team Member 1 should begin to discharge the extinguisher at the base of the fire, continuing the approach until the range for the extinguisher is optimal.

**EXERCISE: SUPPRESSING SMALL FIRES (CONTINUED)**

5. Team Member 1 should sweep the base of the fire until it is extinguished.

**When Team Member 1 is exiting the fire area, he or she should say, “Backing out.” Team Member 2 should repeat the command. Participant 2 should guide Participant 1 from the area with his or her hands as Participant 1 continues facing the fire and looking for hazards.**

After the fire is extinguished, trade positions and repeat the exercise.

---



### UNIT SUMMARY

Effective fire suppression depends on an understanding of:

- The type of fuel involved.
- The elements required for fire to exist.
- The class of fire.
- The resources required and available to extinguish each type of fire.
- Effective fire suppression techniques.

Fire requires heat, fuel, and oxygen to exist.

There are four types, or classes, of fire:

- Class A: Ordinary combustibles
- Class B: Flammable liquids
- Class C: Energized electrical equipment
- Class D: Combustible metals

It is extremely important to identify the class of fire to select the proper extinguisher for the class.

To help understand the types of materials, there are several methods of placarding hazardous materials being stored or transported, including NFPA, DOT, UN, and NA. When faced with accidents involving materials that are placarded as hazardous—or when the material is unknown—keep away and call for professional help immediately.

Portable fire extinguishers are most frequently used for suppressing small fires. Their labels tell the types of fires for which they are effective and the area that they can suppress.

**UNIT SUMMARY (CONTINUED)**

When using portable fire extinguishers, remember P.A.S.S.: Pull, Aim, Squeeze, and Sweep.

When suppressing a fire, always follow the safety rules established for CERTs.

**HOMEWORK ASSIGNMENT**

Before the next session, you should:

- Read and familiarize yourself with Unit 3: Emergency Medical Operations—Part I in the Participant Manual.
- Obtain and bring to the session:
  - 1 box of 4" × 4" bandages.
  - 1 triangular bandage.
  - 1 roll of roller gauze.
  - 1 medical mask.
  - 1 pair of examination gloves.
  - 1 blanket.

Wear comfortable clothes for the next session because you will be practicing medical techniques.

---

---

# UNIT 3: DISASTER MEDICAL OPERATIONS—PART 1

---

---

**In this unit you will learn about:**

- **Life-threatening Conditions:** How to recognize and treat an airway obstruction, bleeding, and shock.
- **Triage:** Principles of triage and how to conduct triage evaluations.



**UNIT 3: DISASTER MEDICAL OPERATIONS—PART 1**

---

**INTRODUCTION AND UNIT OVERVIEW**

The need for disaster medical operations is based on two assumptions:

- The number of victims will exceed the local capacity for treatment.
- Survivors will assist others. They will do whatever they know how to do. They need to know lifesaving or post-disaster survival techniques.

There are three phases of death from trauma:

- Phase 1: Death within minutes as a result of overwhelming and irreversible damage to vital organs
- Phase 2: Death within several hours as a result of excessive bleeding
- Phase 3: Death in several days or weeks as a result of infection or multiple-system failure (i.e., complications from the injury)

Peter Safer's research after earthquakes in Chile, Peru, and Italy indicated that more than 40 percent of disaster victims in the second and third phases of death from trauma could be saved by providing simple medical care.

CERT personnel are trained to provide:

- Treatment for life-threatening conditions—airway obstruction, bleeding, and shock—and for other less urgent conditions.
- The greatest good for the greatest number of victims by conducting simple triage and rapid treatment.

In a disaster, there will be more victims than rescuers and that immediate help will not be available. CERTs must be able to function quickly and efficiently to save lives.

---

**COMMUNITY EMERGENCY RESPONSE TEAM**  
**UNIT 3: DISASTER MEDICAL OPERATIONS—PART 1**

---

**INTRODUCTION AND UNIT OVERVIEW (CONTINUED)**

**OBJECTIVES**

At the end of this unit, you should be able to:

- Identify the “killers.”
- Apply techniques for opening the airway, controlling bleeding, and treating for shock.
- Conduct triage under simulated disaster conditions.

The goal of disaster medical operations is to do the greatest good for the greatest number. In a disaster with many victims, time will be critical. CERT members will need to work quickly and efficiently to help as many victims as possible.

This unit will introduce you to the “three killers” and the principles of triage. Throughout the unit, you will have opportunities to practice the treatment techniques and, at the end of the unit, you will have the opportunity to conduct triage evaluations in a simulated disaster.

The first section will deal with treatment for life-threatening conditions: Airway obstruction, excessive bleeding, and shock.

---

### TREATING LIFE-THREATENING CONDITIONS

In emergency medicine, airway obstruction, bleeding, and shock are “killers.” The first priority of medical operations is to attend to those potential killers by:

- Opening the airway.
- Controlling excessive bleeding.
- Treating for shock.

This section will train you to recognize the “killers” by recognizing their symptoms and their effects on the body.

Always wear safety equipment: Helmet, goggles, gloves, mask, and boots. A timesaving technique is to wear latex gloves under your work gloves. Then, when you find a victim, you can remove your work gloves and are ready to work with the victim.

#### OPENING THE AIRWAY

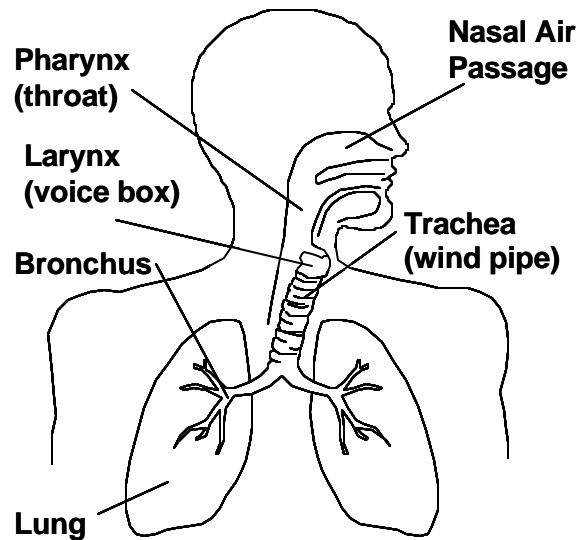

**Components Of the Respiratory System**

Components Of the Respiratory System, showing the pharynx, nasal air passage, larynx, trachea, bronchus.

The respiratory system includes airways, lungs, and muscles.

TREATING LIFE-THREATENING CONDITIONS (CONTINUED)

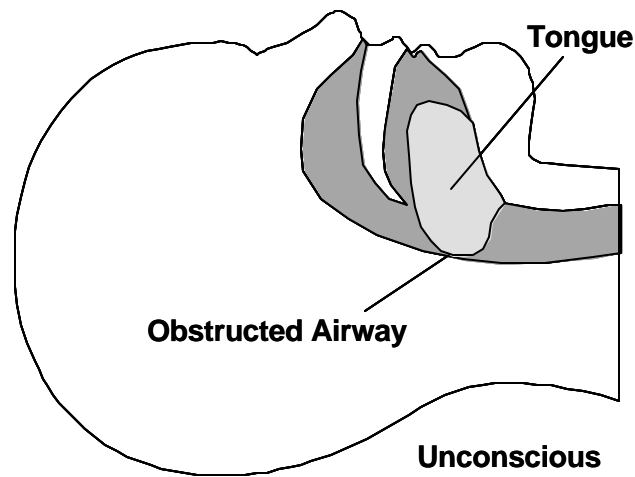

**Airway Obstructed By The Tongue**

The most common airway obstruction is the tongue. In an unconscious or semiconscious victim, especially one positioned on his or her back, the tongue—which is a muscle—may relax and block the airway. A victim with a suspected airway obstruction must be checked immediately for breathing and, if necessary, the airway must be opened.

When an airway obstruction is suspected, CERT members should clear the airway using the Head-Tilt/Chin-Lift method.

**Head-Tilt/Chin-Lift Method for Opening an Airway**

Step	Action
1	At an arm's distance, shake the victim by touching the shoulder and shout, "Can you hear me?"
2	If the victim does not or cannot respond, place the palm of one hand on the forehead.
3	Place two fingers of the other hand under the chin and tilt the jaw upward while tilting the head back slightly.
4	Place your ear over the victim's mouth, looking toward the victim's feet, and place a hand on the victim's abdomen.
5	<i>Look</i> for chest rise.
6	<i>Listen</i> for air exchange.
7	<i>Feel</i> for abdominal movement.



**TREATING LIFE-THREATENING CONDITIONS (CONTINUED)**

**EXERCISE: OPENING THE AIRWAY**

**Purpose:** This exercise allows you to practice using the Head-Tilt/Chin-Lift method on each other.

**Instructions:** Follow the steps below to complete this exercise:

1. Work in pairs—one person will be the victim and the other person the rescuer.
2. Victims should lie on the floor on their backs and close their eyes.
3. The rescuer should use the Head-Tilt/Chin-Lift method on the victim to open the airway.
4. After the rescuer has made two or three attempts at using the Head-Tilt/Chin-Lift method, the victim and the rescuer should change roles.

### **TREATING LIFE-THREATENING CONDITIONS (CONTINUED)**

Part of your mission is to do the greatest good for the greatest number of people. For that reason, if breathing is not restored on the first try using the Head-Tilt/Chin-Lift method, CERT members should try again using the same method. If breathing cannot be restored on the second try, CERT members must move on to the next victim.

If breathing has been restored, the airway still must be maintained. One option is to use a volunteer or walking wounded to hold the head in place. The airway also can be maintained by placing soft objects under the victim's shoulders to elevate the shoulders slightly and keeping the airway open.

#### **CONTROLLING BLEEDING**

Uncontrolled bleeding initially causes weakness. If bleeding is not controlled, the victim will go into shock within a short period of time, and finally will die. An adult has about five liters of blood. Losing one liter can result in death.

There are three types of bleeding and the type can usually be identified by how fast the blood flows:

- Arterial bleeding. Arteries transport blood under high pressure. Bleeding from an artery is spurting bleeding.
- Venous bleeding. Veins transport blood under low pressure. Bleeding from a vein is flowing bleeding.
- Capillary bleeding. Capillaries also carry blood under low pressure. Bleeding from capillaries is oozing bleeding.

There are three main methods for controlling bleeding:

- Direct pressure
- Elevation
- Pressure points

TREATING LIFE-THREATENING CONDITIONS (CONTINUED)  
Procedures For Controlling Bleeding

Method	Procedures
Direct Pressure	<ul style="list-style-type: none"><li>▪ Place direct pressure over the wound by putting a clean dressing over the wound and pressing firmly.</li><li>▪ Maintain pressure on the dressing over the wound by wrapping the wound <u>firmly</u> with a pressure bandage.</li></ul>
Elevation	<ul style="list-style-type: none"><li>▪ Elevate the wound above the level of the heart.</li></ul>
Pressure Points	<ul style="list-style-type: none"><li>▪ Put pressure on the nearest pressure point to slow the flow of blood to the wound. Use the:<ul style="list-style-type: none"><li>• Brachial point for bleeding in the arm.</li><li>• Femoral point for bleeding in the leg.</li></ul></li></ul> <p>(See the figures on the following page for illustrations of these pressure points.)</p> <p>There are other pressure points that the Instructor may demonstrate.</p>

Direct pressure combined with elevation will address most bleeding. Demonstrate the procedure for controlling bleeding through direct pressure:

- Step 1: Place direct pressure over the wound by putting a clean dressing over the wound and pressing firmly.
- Step 2: Maintain pressure on the dressing over the wound by wrapping firmly with a pressure bandage.

Direct pressure and elevation can take 5 to 7 minutes to stop the bleeding completely. The use of a dressing and pressure bandage allows the rescuer to move on to the next victim.

A pressure bandage should be tied with a bow, so that it can be loosened—rather than cut—to examine the wound, and then retied. This procedure helps to conserve supplies and saves time.

Bleeding can also be controlled through elevation: Elevating the wound above the level of the heart. Elevation is used in combination with direct pressure.

There are also pressure points that can be used to stem the flow of bleeding.

**TREATING LIFE-THREATENING CONDITIONS (CONTINUED)**

The pressure points most often used are the:

- Brachial point in the arm.
- Femoral point in the leg.

Get victims to help themselves, whenever possible.



**Brachial Pressure Point**

**Brachial Pressure Point,  
just above the elbow.**

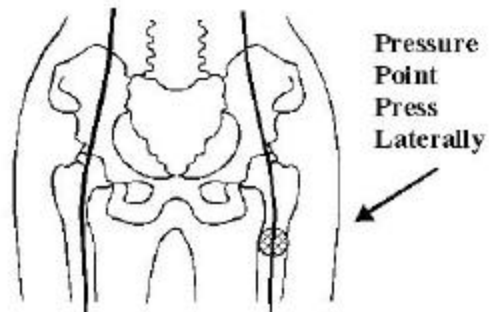

**Femoral Pressure Point**

**Femoral Pressure Point, in the  
Upper thigh.**

TREATING LIFE-THREATENING CONDITIONS (CONTINUED)

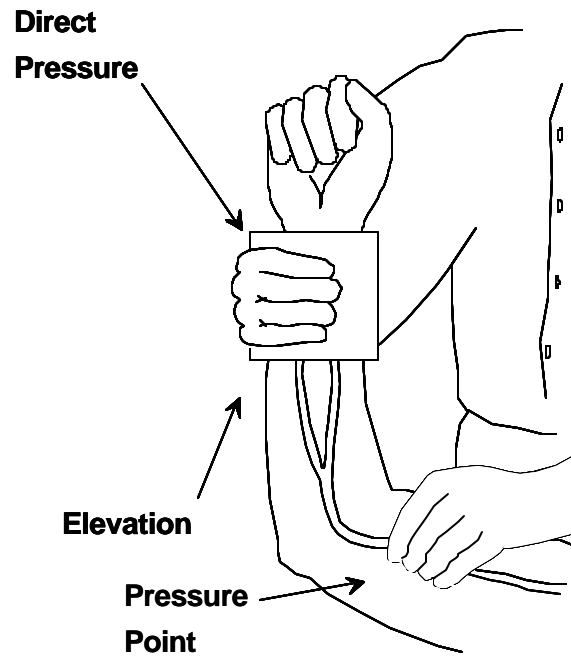

Methods For Controlling Bleeding

Methods For Controlling Bleeding by using direct pressure on wound, elevation, and pressure points.

**TREATING LIFE-THREATENING CONDITIONS (CONTINUED)**

**EXERCISE: CONTROLLING BLEEDING**

**Purpose:** This exercise allows you to practice the techniques for controlling bleeding.

**Instructions:** Follow the steps below to conduct this exercise:

1. Work in pairs again – one person will be the victim and the other the rescuer.
2. Victims should lie on the floor on their backs and close their eyes.
3. The rescuer should use direct pressure to control bleeding from a simulated wound on the right forearm just below the elbow. The rescuer should:
  - Apply a pressure bandage.
  - Elevate the arm.
  - Repeat these two steps.
  - Repeat the two steps for speed.
4. After the rescuer has made at least three attempts at using each technique, the victim and the rescuer should change roles.

Bleeding must be controlled as quickly as possible so as not to endanger the victim's life from blood loss.

You should always wear your rubber gloves, goggles, and a mask as a protection against blood-borne pathogens, such as hepatitis and HIV.

**TREATING LIFE-THREATENING CONDITIONS (CONTINUED)**

**RECOGNIZING AND TREATING SHOCK**

Shock is a disorder resulting from ineffective circulation of blood. Remaining in shock will lead to the death of:

- Cells.
- Tissues.
- Entire organs.

The body will initially compensate for blood loss and mask the symptoms of shock. Therefore, it is important to continually evaluate patients for shock and monitor their condition.

The main signs of shock that CERT members look for are:

- Rapid and shallow breathing.
- Capillary refill of greater than 2 seconds.
- Failure to follow simple commands, such as, “Squeeze my hand.”
- Changes in skin color.

Capillary refill is how long it takes for the color to return. This is called the “blanch test.”

**TREATING LIFE-THREATENING CONDITIONS (CONTINUED)**

Although victims who are suffering from shock may be thirsty, they should not eat or drink anything, because they may also be nauseated.

**Procedures For Controlling Shock**

Step	Action
1	<ul style="list-style-type: none"><li>▪ Lay the victim on his or her back.</li><li>▪ Elevate the feet 6-10 inches above the level of the heart.</li><li>▪ Maintain an open airway.</li></ul>
2	<ul style="list-style-type: none"><li>▪ Control obvious bleeding.</li></ul>
3	<ul style="list-style-type: none"><li>▪ Maintain body temperature (e.g., cover the ground and the victim with a blanket if necessary).</li></ul>
4	<ul style="list-style-type: none"><li>▪ Avoid rough or excessive handling unless the rescuer and victim are in immediate danger.</li></ul>

**EXERCISE: TREATING SHOCK**

**Purpose:** This exercise allows you to practice the steps for treating shock.

**Instructions:** Follow the steps below to complete this exercise:

1. Work in pairs of victim and rescuer.
  2. The victims should lie on the floor on their backs and close their eyes.
  3. The rescuer should treat the victim based on the scenario given by the Instructor.
  4. The victim and the rescuer should then switch roles.
-



## **TRIAGE**

Triage is a French term meaning “to sort.”

During triage, victims are evaluated, sorted by the urgency of the treatment needed, and set up for immediate or delayed treatment.

Triage was, in fact, initiated by the military and experience has shown that triage is an effective strategy in situations where:

- There are many more victims than rescuers.
- There are limited resources.
- Time is critical.

Triage occurs as quickly as possible after a victim is located or rescued.

During triage, victims' conditions are evaluated and the victims are prioritized and labeled (tagged) into three categories:

- Immediate (I): The victim has life-threatening (airway, bleeding, or shock) injuries that demand immediate attention to save his or her life; rapid, life-saving treatment is urgent.
- Delayed (D): Injuries do not jeopardize the victim's life. The victim may require professional care, but treatment can be delayed.
- Dead (DEAD): No respiration after two attempts to open the airway. Because CPR is one-on-one care and is labor-intensive, CPR is not performed when there are many more victims than rescuers.

The CERT program goal is to do the greatest good for the greatest number.

From triage, victims are taken to the designated medical treatment area (immediate care, delayed care, or morgue). (Note: If you have labeled your medical treatment areas using “I,” “D,” and “Morgue,” you can tell spontaneous volunteers to take the “I” victims to the “I” treatment area, etc.)

---

**COMMUNITY EMERGENCY RESPONSE TEAM**  
**UNIT 3: DISASTER MEDICAL OPERATIONS—PART 1**

---

**TRIAGE (CONTINUED)**

**TRIAGE IN A DISASTER ENVIRONMENT**

The general procedures for conducting triage are:

- Step 1: Stop, Look, Listen, and Think. Before you start, stop and size up the situation by looking around and listening. **THINK** about your safety, capability, and limitations, and decide if you will approach the situation and how.
- Step 2: Conduct voice triage. Begin by calling out, “Emergency Response Team. If you can walk, come to the sound of my voice.” If there are survivors who are ambulatory, instruct them to remain at a designated location, and continue with the triage operation. (If rescuers need assistance and there are ambulatory survivors, then these survivors should be asked to provide assistance.) These persons may also provide useful information about the location of the victims.
- Step 3: Start where you stand, and follow a systematic route. Start with the closest victims and work outward in a systematic fashion.
- Step 4: Evaluate each victim and tag them “I” (immediate), “D” (delayed), or “DEAD.” Remember to evaluate the walking wounded.
- Step 5: Treat “I” victims immediately. Initiate airway management, bleeding control, and treatment for shock for “I” victims.
- Step 6: Document triage results for:
  - Effective deployment of resources.
  - Information on the victims’ locations.
  - A quick record of the number of casualties by degree of severity.

The rescuer’s safety is paramount during triage. Wear proper protective equipment so as not to endanger your own health.

**TRIAGE (CONTINUED)**

**PERFORMING A TRIAGE EVALUATION**

**Triage Procedure**

Step	Procedures
1	<p>Check airway/breathing. At an arm's distance, shake the victim and shout. If the victim does not respond:</p> <ul style="list-style-type: none"><li>▪ Position the airway.</li><li>▪ Look, listen, and feel.</li><li>▪ Check breathing rate. Abnormally rapid respiration (above 30 per minute) indicates shock. Treat for shock and tag "I."</li><li>▪ If below 30 per minute, then move to Step 2.</li><li>▪ If the victim is not breathing after 2 attempts to open airway, then tag "DEAD."</li></ul>
2	<ul style="list-style-type: none"><li>▪ Check circulation/bleeding.</li><li>▪ Take immediate action to control severe bleeding.</li><li>▪ Check circulation using the blanch test (for capillary refill).<ul style="list-style-type: none"><li>• Press on an area of skin until normal skin color is gone. A good place to do this is on the palm of the hand. The nailbeds are sometimes used.</li><li>• Time how long it takes for normal color to return.</li></ul></li><li>▪ Treat for shock if normal color takes longer than 2 seconds to return, and tag "I."</li></ul>
3	<p>Check mental status. Give a simple command, such as "Squeeze my hand." Inability to respond indicates that immediate treatment for shock is necessary. Treat for shock and tag "I."</p>

If the victim passes all tests, his or her status is "D." If the victim fails one test, his or her status is "I." Remember that everyone gets a tag. All victims tagged "I" get airway control, bleeding control, and treatment for shock.

**COMMUNITY EMERGENCY RESPONSE TEAM**  
**UNIT 3: DISASTER MEDICAL OPERATIONS—PART 1**

**TRIAGE (CONTINUED)**

**DOCUMENTING TRIAGE**

**Sample Triage Documentation**

Status	Location			
	A	B	C	D
I	1	2	0	1
D	0	2	5	3
Dead	3	7	1	0

**TRIAGE (CONTINUED)**

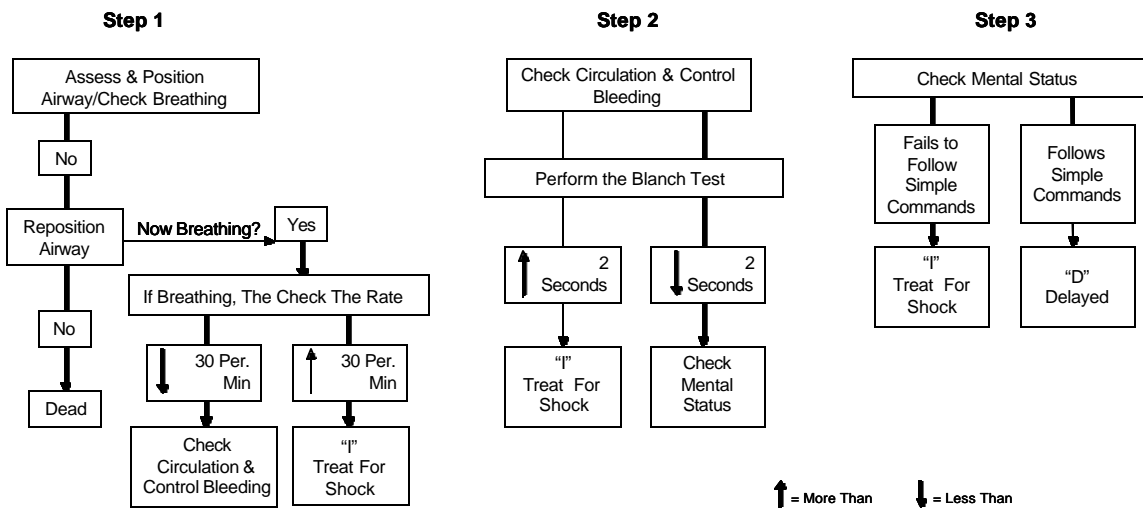

**Triage Decision Flowchart**

**Triage Decision Flowchart, showing the three steps in the triage process. Step 1: assess and position the airway and check breathing; Step 2: Check circulation and control bleeding; Step 3: Check mental status.**

Time will be critical in a disaster. You will not be able to spend very much time with any single victim.

Take advantage of local exercises as a means of maintaining your triage skills and to avoid the triage pitfalls.

Triage pitfalls include:

- No team plan, organization, or goal.
- Indecisive leadership.
- Too much focus on one injury.
- Treatment (rather than triage) performed.

**TRIAGE (CONTINUED)**

**EXERCISE: CONDUCTING TRIAGE**

**Purpose:** This exercise is intended to allow you to practice conducting triage in a high-pressure situation.

**Instructions:** Follow the steps below to complete this exercise:

1. Work in 6-person groups. In each group, three participants will act as victims, and three will act as search and rescue team members (two rescuers and one runner).
  2. The “victims” should select a card from the Instructor and tape it to their shirts.
  3. The victims should arrange themselves within the designated “disaster” area.
  4. The three “rescuers” will have 5 minutes to:
    - Conduct triage on each of the victims and determine how each should be tagged and treated.
    - Document the number of victims in each category of triage (immediate, delayed, dead).
-

### **UNIT SUMMARY**

The key points from this unit include:

- CERT members' ability to open airways, control bleeding, and treat shock is critical to saving lives.
  - Use the Head-Tilt/Chin-Lift method for opening airways.
  - Control bleeding using direct pressure, elevation, and/or pressure points.
  - If there is a question about whether a victim is in shock, treat for shock.
  
- Triage is a system for rapidly evaluating victims' injuries and prioritizing them for treatment. The procedure for conducting triage evaluations involves checking:
  - The airway and breathing rate.
  - Circulation and bleeding.
  - Mental status.

Disaster medical operations require careful planning, teamwork, and practice. Take advantage of participating in community-wide disaster exercises whenever they are scheduled.

### **HOMEWORK ASSIGNMENT**

Read and become familiar with Unit 4: Disaster Medical Operations— Part 2 before the next session.

Bring a blanket, roller gauze, adhesive tape, and cardboard to the next session.

---





---

# UNIT 4: DISASTER MEDICAL OPERATIONS—PART 2

---

---

**In this unit you will learn about:**

- **Public Health Considerations:** How to maintain hygiene and sanitation.
- **Functions of Disaster Medical Operations:** How to conduct the four major subfunctions of disaster medical operations.
- **Disaster Medical Treatment Areas:** How to establish them and what their functions are.
- **Patient Evaluation:** How to perform a head-to-toe patient evaluation to identify and treat injuries.
- **Basic Treatment—How To:**
  - Treat burns.
  - Dress and bandage wounds.
  - Treat fractures, dislocations, sprains, and strains.
  - Apply splints to hands, arms, and legs.
  - Treat hypothermia.
  - Control nasal bleeding.



**UNIT 4: DISASTER MEDICAL OPERATIONS—PART 2**

---

**INTRODUCTION AND UNIT OVERVIEW**

This unit will cover:

- Public health concerns related to sanitation, hygiene, and water purification.
- Organization of disaster medical operations.
- Establishing treatment areas.
- Conducting head-to-toe assessments.
- Treating wounds, fractures, sprains, and other common injuries.

**OBJECTIVES**

At the end of this unit, you should be able to:

- Take appropriate sanitation measures to protect the public health.
  - Perform head-to-toe patient assessments.
  - Establish a treatment area.
  - Apply splints to suspected fractures and sprains, and employ basic treatments for other wounds.
-

---

**COMMUNITY EMERGENCY RESPONSE TEAM**  
**UNIT 4: DISASTER MEDICAL OPERATIONS—PART 2**

---

**PUBLIC HEALTH CONSIDERATIONS**

When disaster victims are sheltered together for treatment, public health becomes a concern. Measures must be taken, both by CERT members and programmatically, to avoid the spread of disease.

The primary public health measures include:

- Maintaining proper hygiene.
- Maintaining proper sanitation.
- Purifying water (if necessary).

**MAINTAINING HYGIENE**

Maintenance of proper hygiene is critical even under makeshift conditions.

Some steps that individual workers can take to maintain hygiene are to:

- Wash hands frequently using soap and water. Hand washing should be thorough (at least 12 to 15 seconds) with an antibacterial scrub if possible.
- Wear latex gloves at all times. Change or disinfect gloves after examining and/or treating each patient. As explained earlier, under field conditions, workers can use rubber gloves that are sterilized between treating victims using bleach and water (1 part bleach to 10 parts water).
- Wear a mask and goggles. If possible, wear a mask that is rated “N95.”
- Keep dressings sterile. Do not remove the overwrap from dressings and bandages until use. After opening, use the entire dressing or bandage, if possible.
- Avoid contact with body fluids. Thoroughly wash areas that come in contact with body fluids with soap and water or diluted bleach as soon as possible.

**MAINTAINING SANITATION**

Poor sanitation is also a major cause of illness, disease, and death.

**PUBLIC HEALTH CONSIDERATIONS (CONTINUED)**

CERT medical operations personnel can maintain sanitary conditions by:

- Controlling the disposal of bacterial sources (e.g., latex gloves, dressings, etc.).
- Putting waste products in plastic bags, tying off the bags, and marking them as medical waste. Keep medical waste separate from other trash, and dispose of it as hazardous waste.
- Burying human waste.

**WATER PURIFICATION**

Potable water supplies are often in short supply or are not available in a disaster. Purify water for drinking, cooking, and medical use by heating it to a rolling boil for 1 minute, or by using water purification tablets or unscented liquid bleach.

Rescuers should not put anything on wounds other than purified water. The use of other solutions (e.g., hydrogen peroxide) on wounds must be the decision of trained medical personnel.

CERT members must use latex gloves, goggles, and a mask during all medical operations, and they must cover all open wounds as a way of preventing the spread of disease.

---

**COMMUNITY EMERGENCY RESPONSE TEAM**  
**UNIT 4: DISASTER MEDICAL OPERATIONS—PART 2**

**FUNCTIONS OF DISASTER MEDICAL OPERATIONS**

There are four major subfunctions of disaster medical operations:

- Triage: The initial assessment and sorting of victims for treatment based on the severity of their injuries
- Treatment: The area in which disaster medical services are provided to victims
- Transport: The movement of victims from the triage area to the treatment area. If professional help will be delayed, for efficiency of operations, victims can be transported to the treatment area by CERT members
- Morgue: The temporary holding area for victims who have died as a result of their injuries

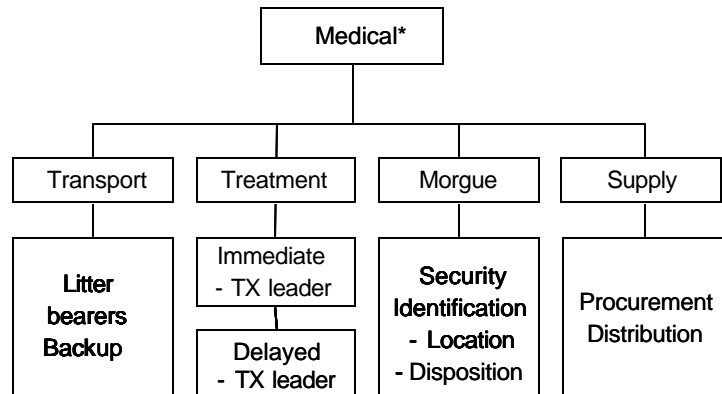

**Disaster Medical Operations Organization**

**Disaster Medical Operations Organization, showing the subfunctions of disaster medical operations: Transport, Treatment, Morgue, and Supply.**

\* Note that triage is organized under search and rescue.

FUNCTIONS OF DISASTER MEDICAL OPERATIONS (CONTINUED)

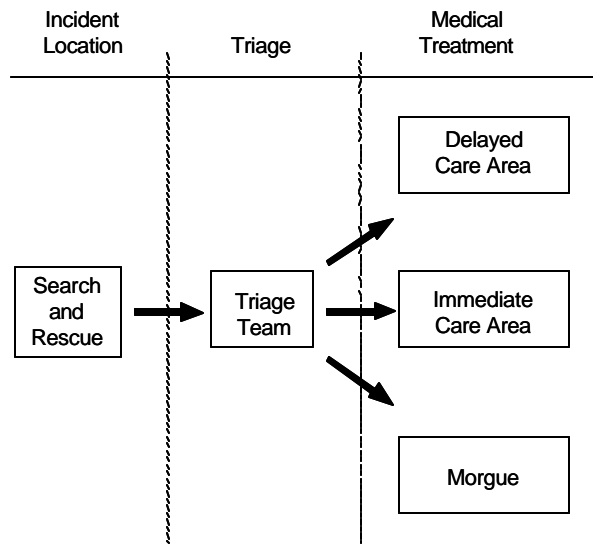

Patient Flowchart

Patient Flowchart, which shows how the patients are rescued, triaged, and sent to the medical treatment areas according to the extent of their injuries (“I,” “D,” or “Dead”).

### **ESTABLISHING TREATMENT AREAS**

Because time is critical during a disaster, CERT medical operations personnel will need to select a site and set up a treatment area as soon as injured victims are confirmed.

The treatment area is the location where the most advanced medical care possible will be given to victims.

The site selected should be:

- In a safe area, free of hazards and debris.
- Close to, but upwind and uphill from, the hazard zone(s).
- Accessible by transportation vehicles (ambulances, trucks, helicopters, etc.).
- Expandable.

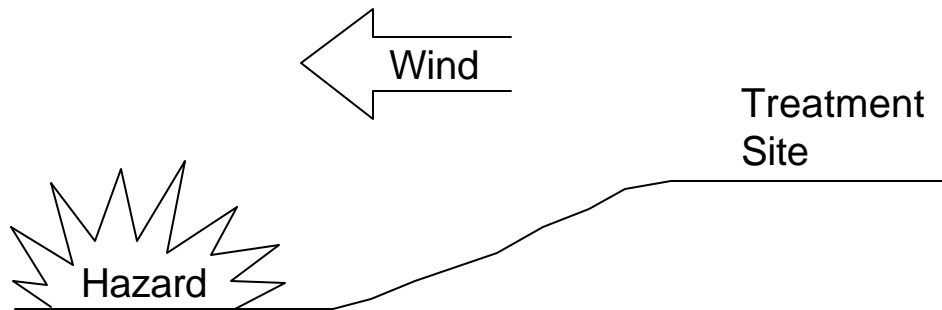

**Treatment Area Site Selection**

**Treatment Area Site Selection, uphill and upwind from hazard.**

### **TREATMENT AREA LAYOUT**

The treatment area must be protected and clearly delineated using a ground cover or tarp, and signs should identify the subdivisions of the area:

- “I” for Immediate care
- “D” for Delayed care
- “DEAD” for the morgue

The “I” and “D” divisions should be relatively close to each other to allow:

- Verbal communication between workers in the two areas.
- Shared access to medical supplies (which should be cached in a central location).
- Easy transfer of patients whose status has changed.



### ESTABLISHING TREATMENT AREAS (CONTINUED)

A clearly marked treatment area will help in transporting victims to the correct location.

Patients in the treatment area should be positioned in a head-to-toe configuration, with two to three feet between victims.

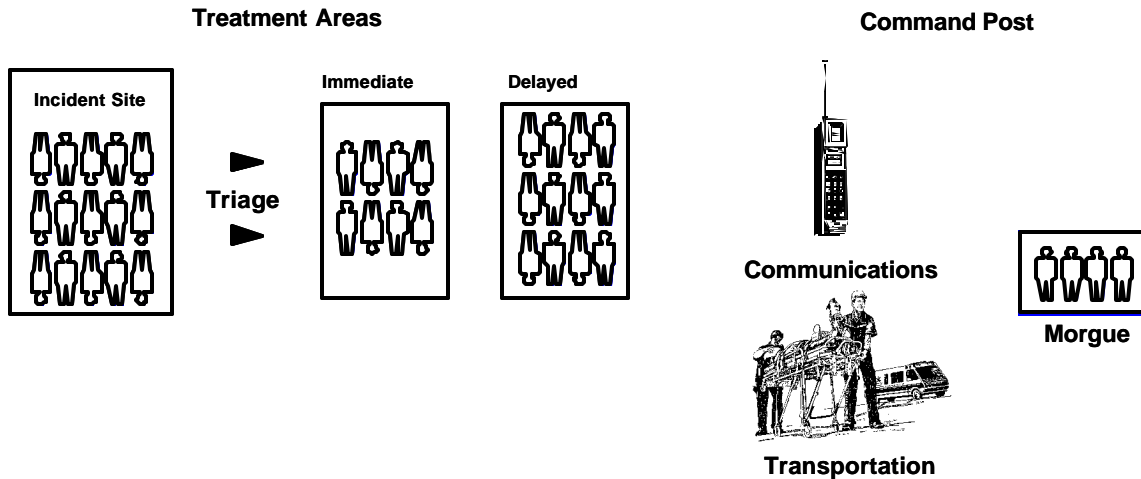

#### Treatment Area Layout

Treatment Area Layout, showing the organization for the incident site, triage, communications, transportation, and morgue.

This system will provide:

- Effective use of space.
- Effective use of available personnel. (As a worker finishes one head-to-toe assessment, he or she turns around and finds the head of the next patient.)

#### TREATMENT AREA ORGANIZATION

The CERT team must assign leaders to maintain control in each of the medical treatment areas. These leaders will:

- Ensure orderly victim placement.
- Direct assistants to conduct head-to-toe assessments.

**ESTABLISHING TREATMENT AREAS (CONTINUED)**

Thoroughly document victims in the treatment area, including:

- Available identifying information.
- Description (age, sex, body build, height, weight).
- Clothing.
- Injuries.
- Treatment.
- Transfer location.

**TREATMENT AREA PLANNING**

Remember to plan before disaster strikes, including:

- Roles of personnel assigned to the treatment area.
- Availability of setup equipment needed, such as ground covers/tarps and signs for identifying divisions (immediate, delayed, morgue).

Take part in practice exercises so that you can develop a good operational plan and practice rapid treatment area setup.

---

### **CONDUCTING HEAD-TO-TOE ASSESSMENTS**

The first steps that you will take when working with a victim will be to conduct a triage and rapid treatment. After all victims in an area have been triaged CERT members will begin a thorough head-to-toe assessment of the victim's condition.

During triage, you looked for “the killers.”

- Airway obstruction.
- Excessive bleeding.
- Signs of shock.

A head-to-toe assessment goes beyond the “killers” to try to gain more information to determine the nature of the victim's injury. During a head-to-toe assessment, look for the following:

- Bruising.
- Swelling.
- Severe pain.
- Disfigurement.

A head-to-toe assessment can be done in place in a lightly damaged building. If the building is moderately damaged, the victim should be moved to a safe zone or to the treatment area for the head-to-toe assessment.

The objectives of a head-to-toe assessment are to:

- Determine, as clearly as possible, the extent of injuries.
- Determine what type of treatment is needed.
- Document injuries.

**CONDUCTING HEAD-TO-TOE ASSESSMENTS (CONTINUED)**

Wear safety equipment when conducting head-to-toe assessments.

Head-to-toe assessments should be:

- Conducted on all victims, even those who seem alright. Everyone gets a tag.
- Verbal (if the patient is able to speak).
- Hands-on.

Whenever possible, you should ask the person about any injuries, pain, bleeding, or other symptoms. If the victim is conscious, CERT members should always ask permission to conduct the assessment. The victim has the right to refuse treatment. Then:

- Pay careful attention.
- Look, listen, and feel for anything unusual.

Conduct head-to-toe assessments systematically, checking body parts from the top to the bottom for continuity of bones and soft tissue injuries in the following order:

1. Head
2. Neck
3. Shoulders
4. Chest
5. Arms
6. Abdomen
7. Pelvis
8. Legs
9. Back

Completing the assessment in the same way every time will make the procedure quicker and more accurate.

Check your own hands for patient bleeding as you complete the head-to-toe assessment.

Perform an entire assessment before beginning any treatment. Also, treat all unconscious victims as if they have a spinal injury.

**CONDUCTING HEAD-TO-TOE ASSESSMENTS (CONTINUED)**

**CLOSED-HEAD, NECK, AND SPINAL INJURIES**

When conducting head-to-toe assessments, rescuers may come across victims who have or may have suffered closed-head, neck, or spinal injuries.

The main objective when CERT members encounter suspected injuries to the head or spine is to do no harm. You should minimize movement of the head and spine, while treating any other life-threatening conditions.

The signs of a closed-head, neck, or spinal injury most often include:

- Change in consciousness.
- Inability to move one or more body parts.
- Severe pain or pressure in the head, neck, or back.
- Tingling or numbness in extremities.
- Difficulty breathing or seeing.
- Heavy bleeding, bruising, or deformity of the head or spine.
- Blood or fluid in the nose or ears.
- Bruising behind the ear.
- “Raccoon” eyes (bruising around eyes).
- “Uneven” pupils.
- Seizures.
- Nausea or vomiting.
- Victim found under collapsed building material or heavy debris.

**CONDUCTING HEAD-TO-TOE ASSESSMENTS (CONTINUED)**

If the victim is exhibiting any of these signs, he or she should be treated as having a closed-head, neck, or spinal injury.

Keep the spine in a straight line when doing the head-to-toe assessment.

In an extreme emergency, ideal equipment is rarely available, so the CERT members may need to be creative by:

- Looking for materials that can be used as a backboard—a door, desktop, building materials—anything that might be available.
- Looking for items that can be used to stabilize the head on the board—towels, draperies, or sandbags—by tucking them snugly on either side of the head to immobilize it.

**EXERCISE: CONDUCTING HEAD-TO-TOE ASSESSMENTS**

**Purpose:** This exercise allows you to practice conducting head-to-toe assessments.

**Instructions:** Follow the steps below to complete this exercise:

1. Work in two-person teams of victim and rescuer.
  2. Victims should lie on the floor on their backs and close their eyes.
  3. The rescuer should conduct a head-to-toe assessment on the victim following the procedure demonstrated earlier.
  4. After the rescuer has made at least two observed head-to-toe assessments, the victim and rescuer should change roles.
-

### **TREATING BURNS**

The objectives of first aid treatment for burns are to:

- Cool the burned area.
- Cover with a sterile cloth to reduce the risk of infection (by keeping fluids in and germs out).

Burns may be caused by heat, chemicals, electrical current, and radiation. The severity of a burn depends on the:

- Temperature of the burning agent.
- Period of time that the victim was exposed.
- Area of the body that was affected.
- Size of the area burned.
- Depth of the burn.

### **BURN CLASSIFICATIONS**

The skin has three layers:

- The epidermis, or outer layer of skin, contains nerve endings and is penetrated by hairs.
- The dermis, or middle layer of skin, contains blood vessels, oil glands, hair follicles, and sweat glands.
- The subcutaneous layer, or innermost layer, contains blood vessels and overlies the muscle and skin cells.

Depending on the severity, burns may affect all three layers of skin.

Burns are classified as first, second, or third degree depending on their severity.

**COMMUNITY EMERGENCY RESPONSE TEAM**  
**UNIT 4: DISASTER MEDICAL OPERATIONS—PART 2**

**TREATING BURNS (CONTINUED)**  
**Burn Classifications**

<b>Classification</b>	<b>Skin Layers Affected</b>	<b>Signs</b>
1 <sup>st</sup> Degree	<ul style="list-style-type: none"><li>▪ Epidermis (superficial)</li></ul>	<ul style="list-style-type: none"><li>▪ Reddened, dry skin</li><li>▪ Pain</li><li>▪ Swelling (possible)</li></ul>
2 <sup>nd</sup> Degree	<ul style="list-style-type: none"><li>▪ Epidermis</li><li>▪ Partial destruction of dermis</li></ul>	<ul style="list-style-type: none"><li>▪ Reddened, blistered skin</li><li>▪ Wet appearance</li><li>▪ Pain</li><li>▪ Swelling (possible)</li></ul>
3 <sup>rd</sup> Degree (Full Thickness Burns)	<ul style="list-style-type: none"><li>▪ Complete destruction of epidermis and dermis</li><li>▪ Possible subcutaneous damage (destroys all layers of skin and some or all underlying structures)</li></ul>	<ul style="list-style-type: none"><li>▪ Whitened, leathery, or charred (brown or black)</li><li>▪ Painful or relatively painless</li></ul>

Guidelines for treating burns include:

- Removing the victim from the burning source. Put out any flames and remove smoldering clothing unless it is stuck to the skin.
- Cooling skin or clothing, if they are still hot, by immersing them in cool water for not more than 1 minute or covering with clean compresses that have been wrung out in cool water. Cooling sources include water from the bathroom or kitchen; garden hose; and soaked towels, sheets, or other cloths. Treat all victims of third-degree burns for shock.
- Covering loosely with dry (or moist, based on local protocols), sterile dressings to keep air out and prevent infection.
- Elevating burned extremities higher than the heart.
- Do not use ice. Ice causes vessel constriction.
- Do not apply antiseptics, ointments, or other remedies.
- Do not remove shreds of tissue, break blisters, or remove adhered particles of clothing. (Cut burned-in clothing around the burn.)

Infants, young children, and older persons, and persons with severe burns, are more susceptible to hypothermia. Therefore, rescuers should use caution when applying cool dressings on such persons. A rule of thumb is do not cool more than 15 percent of the body surface area (the size of one arm) at once, to prevent hypothermia.



### **TREATING BURNS (CONTINUED)**

In the next section, you will learn to treat other injuries that are common after disasters:

- Lacerations
  - Amputations and impaled objects
  - Fractures, dislocations, sprains, and strains
  - Nasal injuries
  - Hypothermia
- 

### **WOUND CARE**

This section will focus on cleaning and bandaging to control infection:

The objectives of treatment for wounds are to:

- Control bleeding.
- Prevent secondary infection.

The focus of this section is on cleaning and bandaging, which will help to control infection.

Wounds should be cleaned by irrigating with water, flushing with a mild concentration of soap and water, then irrigating with water again.

You should not scrub the wound. A bulb syringe is useful for irrigating wounds. In a disaster, a turkey baster may also be used.

When the wound is thoroughly cleaned, you will need to apply a dressing and bandage to help keep it clean and control bleeding.

The difference between a dressing and a bandage is that:

- A dressing is applied directly to the wound.
- A bandage holds the dressing in place.

### **WOUND CARE (CONTINUED)**

If a wound is still bleeding, the bandage should place enough pressure on the wound to help control bleeding without interfering with circulation.

Follow these rules:

1. In the absence of active bleeding, dressings must be removed and the wound must be flushed and checked for signs of infection at least every 4 to 6 hours.

Signs of possible infection include:

- Swelling around the wound site.
  - Discoloration.
  - Discharge from the wound.
  - Red striations from the wound site.
2. If there is active bleeding (i.e., if the dressing is soaked with blood), redress over the existing dressing and maintain pressure and elevation to control bleeding.

If necessary based on reassessment and signs of infection, change the treatment priority.

### **AMPUTATIONS**

The main treatments for an amputation (the traumatic severing of a limb or other body part) are to:

- Control bleeding.
- Treat shock.

When the severed body part can be located, CERT members should:

- Save tissue parts, wrapped in clean material and placed in a plastic bag, if available.
- Keep the tissue parts cool.
- Keep the severed part with the victim.

### **IMPALED OBJECTS**

You may also encounter some victims who have foreign objects lodged in their bodies—usually as the result of flying debris during the disaster.

When a foreign object is impaled in a patient's body, you should:

- Immobilize the affected body part.
- Not attempt to move or remove the object unless it is obstructing the airway.

### WOUND CARE (CONTINUED)

- Try to control bleeding at the entrance wound without placing undue pressure on the foreign object.
- Clean and dress the wound. Wrap bulky dressings around the object to keep it from moving.

### TREATING FRACTURES, DISLOCATIONS, SPRAINS, AND STRAINS

The objective when treating a suspected fracture, sprain, or strain is to immobilize the injury and the joints immediately above and below the injury site.

Because it is difficult to distinguish among fractures, sprains, or strains, if uncertain of the type of injury, CERT members should treat the injury as a fracture.

#### FRACTURES

A fracture is a complete break, a chip, or a crack in a bone. There are several types of fractures:

- A closed fracture is a broken bone with no associated wound. First aid treatment for closed fractures may require only splinting.
- An open fracture is a broken bone with some kind of wound that allows contaminants to enter into or around the fracture site.

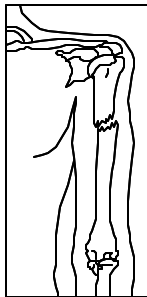

**Closed Fracture**

**Closed Fracture in which the fracture does not puncture the skin.**



**Open Fracture**

**Open Fracture in which the bone protrudes through the skin.**

Open fractures are more dangerous because of the risk of severe bleeding and infection. Therefore, they are a higher priority and need to be checked more frequently.

When treating an open fracture:

- Do not draw the exposed bone ends back into the tissue.
- Do not irrigate the wound.

**TREATING FRACTURES, DISLOCATIONS, SPRAINS, AND STRAINS (CONTINUED)**

You should:

- Cover the wound with a sterile dressing.
- Splint the fracture without disturbing the wound.
- Place a moist 4" x 4" dressing over the bone end to keep it from drying out.

Displaced fractures may be described by the degree of displacement of the bone fragments. If the limb is angled, then there is a displaced fracture.

Nondisplaced fractures are difficult to identify, with the main signs being pain and swelling. Treat a suspected fracture as a fracture until professional treatment is available.



**Displaced Fracture**

Displaced fracture in which the fractured bone is no longer aligned.

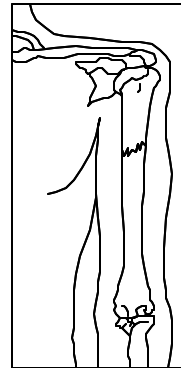

**Nondisplaced Fracture**

Nondisplaced fracture, in which the fractured bone remains aligned.

**DISLOCATIONS**

Dislocations are another common injury in emergencies.

A dislocation is an injury to the ligaments around a joint that is so severe that it permits a separation of the bone from its normal position in a joint.

The signs of a dislocation are similar to those of a fracture, and a suspected dislocation should be treated like a fracture.

You should not try to relocate a suspected dislocation. Immobilize the joint until professional medical help is available.

**TREATING FRACTURES, DISLOCATIONS, SPRAINS, AND STRAINS (CONTINUED)**

**SPRAINS AND STRAINS**

A sprain involves a stretching or tearing of ligaments at a joint and is usually caused by stretching or extending the joint beyond its normal limits.

A sprain is considered a partial dislocation, although the bone either remains in place or is able to fall back into place after the injury.

The most common signs of a sprain are:

- Tenderness at the site of the injury.
- Swelling and/or bruising.
- Restricted use, or loss of use.

The signs of a sprain are similar to those of a nondisplaced fracture. Therefore, do not try to treat the injury other than by immobilization and elevation.

A strain involves a stretching and/or tearing of muscles or tendons. Strains most often involve the muscles in the neck, back, thigh, or calf.

In some cases, strains may be difficult to distinguish from sprains or fractures. When uncertain whether an injury is a strain, sprain, or fracture, treat the injury as if it is a fracture.

---

### **SPLINTING**

Splinting is the most common procedure for immobilizing an injury.

Cardboard is the material typically used for “makeshift” splints but a variety of materials can be used, including:

- Soft materials. Towels, blankets, or pillows, tied with bandaging materials or soft cloths.
- Rigid materials. A board, metal strip, folded magazine or newspaper, or other rigid item.

Anatomical splints may also be created by securing a fractured bone to an adjacent unfractured bone. Anatomical splints are usually reserved for fingers and toes but, in an emergency, legs may also be splinted together.

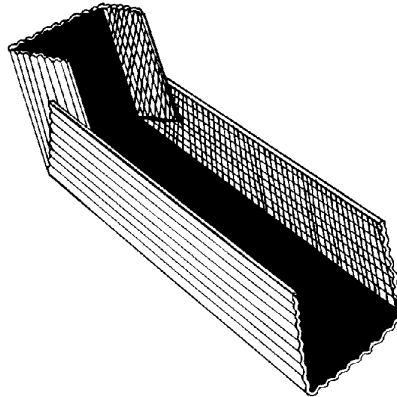

**Cardboard Splint**

**Cardboard Splint in which the edges of the cardboard are turned up to form a “mold” in which the injured limb can rest.**

**SPLINTING (CONTINUED)**

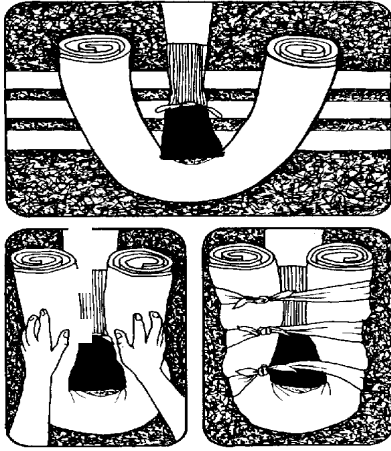

**Splinting Using a Towel**

Splinting using a towel, in which the towel is rolled up and wrapped around the limb, then tied in place.

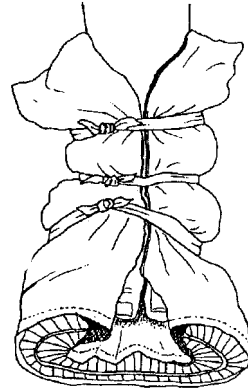

**Pillow Splint**

Pillow splint, in which the pillow is wrapped around the limb and tied.

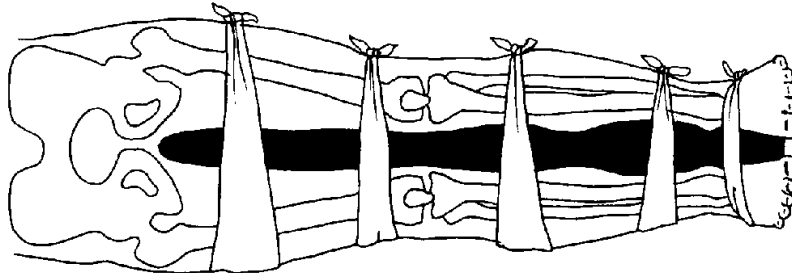

**Splinting Using A Blanket**

Splinting using a blanket in which the victim's legs are immobilized by tying blankets at intervals from mid-thigh to feet.

The guidelines for splinting include:

1. Support the injured area above and below the site of the injury, including the joints.
2. If possible, splint the injury in the position that you find it.
3. Don't try to realign bones or joints.
4. After splinting, check for proper circulation (warmth, feeling, and color).
5. Immobilize above and below the injury.

### **SPLINTING (CONTINUED)**

With this type of injury, there will be swelling. You should remove restrictive clothing, shoes, and jewelry when necessary to prevent these items from acting as tourniquets.

#### **EXERCISE: SPLINTING**

**Purpose:** This exercise allows you to practice the procedures for splinting.

**Instructions:** Follow the steps below to complete this exercise:

1. Working in two-person teams, one person will be the victim and one person will be the rescuer.
  2. Victims should lie on the floor on their backs or sit in a chair.
  3. The rescuer should apply a splint on the victim's upper arm using the procedure demonstrated earlier. Then, the rescuer should apply a splint to the victim's lower leg.
  4. The victim and the rescuer should change roles.
- 

### **NASAL INJURIES**

Bleeding from the nose can be caused by:

- Blunt force to the nose.
- Skull fracture.
- Nontrauma-related conditions such as sinus infections, high blood pressure, and bleeding disorders.

A large blood loss from a nosebleed can lead to shock. Actual blood loss may not be evident because the victim will swallow some amount of blood.

Victims who have swallowed large amounts of blood may become nauseated and vomit.

The methods for controlling nasal bleeding include:

- Pinching the nostrils together.
- Putting pressure on the upper lip just under the nose.



**NASAL INJURIES (CONTINUED)**

While treating for nosebleeds, you should:

- Have the victim sit with the head slightly forward so that blood trickling down the throat will not be breathed into the lungs. Do not put the head back.
- Ensure that the victim's airway remains open.
- Keep the victim quiet. Anxiety will increase blood flow.

---

**TREATING HYPOTHERMIA**

Hypothermia is a condition that occurs when the body's temperature drops below normal.

Hypothermia may be caused by exposure to cold air or water or by inadequate food combined with inadequate clothing and/or heat, especially in older people.

The primary signs and symptoms of hypothermia are:

- A body temperature of 95° Fahrenheit (37° Celsius) or less.
- Redness or blueness of the skin.
- Numbness accompanied by shivering.

In later stages, hypothermia will be accompanied by:

- Slurred speech.
- Unpredictable behavior.
- Listlessness.

### **TREATING HYPOTHERMIA**

Because hypothermia can set in within only a few minutes, you should treat victims who have been rescued from cold air or water environments by:

- Removing wet clothing.
- Wrapping the victim in a blanket or sleeping bag and covering the head and neck.
- Protecting the victim against the weather.
- Providing warm, sweet drinks and food to conscious victims. Do not offer alcohol or massage.
- Placing an unconscious victim in the recovery position.
- Placing the victim in a warm bath if the victim is conscious.

Do not to allow the victim to walk around even when he or she appears to be fully recovered. If the victim must be moved outdoors, you should cover the victim's head and face.

---

### UNIT SUMMARY

To safeguard public health, take measures to maintain proper hygiene and sanitation, and purify water if necessary. All public health measures should be planned in advance and practiced during exercises.

Disaster medical operations includes four subfunctions:

- Triage
- Treatment
- Transport
- Morgue

Head-to-toe assessments should be verbal and hands-on. Always conduct head-to-toe assessments in the same way—beginning with the head and moving toward the feet. If injuries to the head, neck, or spine are suspected, the main objective is to not cause additional injury. Use in-line stabilization and a backboard if the victim must be moved.

Treatment areas must be established as soon as casualties are confirmed. Treatment areas should be:

- In a safe area that is close to, but uphill and upwind from, the hazard area.
- Accessible by transportation vehicles.
- Expandable.

Burns are classified as first, second, or third degree depending on severity and the depth of skin layers involved. Treatment for burns involves removing the source of the burn, cooling the burn, and covering it. For third-degree burns, always treat for shock.

The main first aid treatment for wounds consists of:

- Controlling bleeding.
- Cleaning.
- Dressing and bandaging.

In the absence of active bleeding, dressings must be removed and the wound checked for infection at least every 4 to 6 hours. If there is active bleeding, a new dressing should be placed over the existing dressing.

---

**COMMUNITY EMERGENCY RESPONSE TEAM**  
**UNIT 4: DISASTER MEDICAL OPERATIONS—PART 2**

---

**UNIT SUMMARY (CONTINUED)**

Fractures, sprains, and strains may have similar signs, and diagnosis may not be possible under disaster conditions. Treat suspected fractures, sprains, and strains by immobilizing the affected area using a splint.

**HOMEWORK ASSIGNMENT**

Read and familiarize yourself with Unit 5: Light Search and Rescue Operations before the next session.

Obtain a blanket for use during Unit 5.

---

---

# UNIT 5: LIGHT SEARCH AND RESCUE OPERATIONS

---

---

**In this unit you will learn about:**

- **Search and Rescue Sizeup:** How to size up the situation in which the search and rescue teams will operate.
- **Conducting Search Operations:** How to search systematically for disaster victims.
- **Conducting Rescue Operations:** Safe techniques for lifting, leveraging, cribbing, and victim removal.



**UNIT 5: LIGHT SEARCH AND RESCUE OPERATIONS**

---

**INTRODUCTION AND UNIT OVERVIEW**

Search and rescue consists of three separate operations:

- Sizeup involves assessing the situation and determining a safe action plan.
- Search involves locating victims and documenting their location.
- Rescue involves the procedures and methods required to extricate the victims.

Experience from previous disasters has shown that immediately after almost every disaster, the first response to trapped victims is by spontaneous, untrained, and well-intentioned persons who rush to the site of a collapse in an attempt to free the victims.

More often than not, these spontaneous rescue efforts result in serious injuries and compounded problems.

However well-meaning, rescue efforts should be planned and practiced in advance.

The decision to attempt a rescue should be based on two factors:

- The risks involved to the rescuer
- The overall goal of doing the greatest good for the greatest number of people

The goals of search and rescue operations are to:

- Rescue the greatest number of people in the shortest amount of time.
- Rescue lightly trapped victims first.

The most important person in a rescue attempt is the rescuer.

Effective search and rescue operations hinge on:

- Effective sizeup.
- Rescuer safety.
- Victim safety.

This unit will focus on the components of an effective search and rescue operation—sizeup, search, and rescue—and the methods and techniques that rescuers can use to locate and safely remove victims.

---

**COMMUNITY EMERGENCY RESPONSE TEAM**  
**UNIT 5: LIGHT SEARCH AND RESCUE OPERATIONS**

---

**INTRODUCTION AND UNIT OVERVIEW (CONTINUED)**

**OBJECTIVES**

At the end of this unit, you should be able to:

- Identify sizeup requirements for potential search and rescue situations.
  - Describe the most common techniques for searching a structure.
  - Use safe techniques for debris removal and victim extrication.
  - Describe ways to protect rescuers during search and rescue operations.
- 

**SEARCH AND RESCUE SIZEUP**

Like every other CERT operation, search and rescue requires sizeup at the beginning of the operation and continually as long as the operation continues.

Sizeup is a 9-step process that was presented in Unit 2. This section will focus on sizeup as it relates to search and rescue operations.





CERT Search and Rescue Sizeup Checklist

**Step 1: Gather Facts**

*Time*

- Does the time of day or week affect search and rescue efforts? • •

How?

*Type Of Construction*

- What type(s) of structure(s) is(are) involved?
  
- What type(s) of construction is (are) involved?

*Occupancy*

- Are the structures occupied? • •  
If yes, how many people are likely to be affected?

- Are there special considerations (e.g. children, elderly)? • •

If yes, what are the special considerations?

**COMMUNITY EMERGENCY RESPONSE TEAM**  
**UNIT 5: LIGHT SEARCH AND RESCUE OPERATIONS**

**CERT Search and Rescue Sizeup Checklist**

	<b>Yes</b>	<b>No</b>
<b>Step 1: Gather Facts (Continued)</b>		
<i>Weather</i>		
▪ Will weather conditions affect your safety? If yes, how will your safety be affected?	•	•
▪ Will weather conditions affect the search and rescue situation? If yes, how will the search and rescue situation be affected?	•	•
<i>Hazards</i>		
▪ Are hazardous materials involved? If yes, what hazardous materials?	•	•
▪ Are any other types of hazards likely to be involved? If yes, what other hazards?	•	•

CERT Search and Rescue Sizeup Checklist

	Yes	No
<b>Step 2: Assess and Communicate the Damage</b>		
▪ Take a lap around the building. Is the damage beyond the CERT team's capability?  If yes, what special requirements or qualifications are required?	•	•
▪ Are normal communication channels functioning?	•	•
<b>Step 3: Consider Probabilities</b>		
<i>Life Hazards</i>		
▪ Are there potentially life-threatening hazards?  If yes, what are the hazards?	•	•
<i>Additional Damage</i>		
▪ Is there great risk or potential for more disaster activity that will impact personal safety?  If yes, what are the known risks?	•	•
<b>Step 4: Assess Your Own Situation</b>		
▪ What resources are available with which you can attempt the search and rescue?		
▪ What equipment is available?		

**COMMUNITY EMERGENCY RESPONSE TEAM**  
**UNIT 5: LIGHT SEARCH AND RESCUE OPERATIONS**

**CERT Search and Rescue Sizeup Checklist**

	<b>Yes</b>	<b>No</b>
<b>Step 5: Establish Priorities</b>		
▪ Can a search and rescue be <i>safely</i> attempted by CERT members?	•	•
If no, do <i>not</i> attempt a search and rescue.		
▪ Are there other, more pressing needs at the moment?	•	•
If yes, list.		
 <b>Step 6: Make Decisions</b>		
▪ Where will deployment of available resources do the most good while maintaining an adequate margin of safety?		
 <b>Step 7: Develop Plan of Action</b>		
▪ Determine how personnel and other resources should be deployed.		

**CERT Search and Rescue Sizeup Checklist**

**Step 8: Take Action**

- Put the plans into effect.

**Step 9: Evaluate Progress**

- Continually size up the situation to identify changes in the:
  - Scope of the problem.
  - Safety risks.
  - Resource availability.
- Adjust strategies as required.

---

**COMMUNITY EMERGENCY RESPONSE TEAM**  
**UNIT 5: LIGHT SEARCH AND RESCUE OPERATIONS**

---

**SEARCH AND RESCUE SIZEUP (CONTINUED)**

**STEP 1: GATHER FACTS**

The facts of the situation must guide your search and rescue efforts.

When gathering facts, you need to consider:

- The time of the event and day of the week. At night, more people will be in their homes, so the greatest need for search and rescue will be in residential settings. Conversely, during the day, people will be at work, so the need will be in commercial buildings.

Some emergency services are not available—or not available in the same numbers—during the evenings or on weekends. Search and rescue operations may also be affected by where people are located in their homes and the amount of daylight available.

- The type of structure. The purpose for which the structure was designed may indicate the likely number of victims, and their location.
- Construction type. Some types of construction are more susceptible to damage than others.
- Weather. Severe weather will have an effect on victims and rescuers alike and will certainly hamper rescue efforts. Forecasts of severe weather should be considered as a limiting factor on the time period during which search and rescue can occur.
- Hazards. Knowledge of other potential hazards in the general and immediate areas is important to search and rescue efforts. Time lost trying to locate and shut off utilities, for example, can have a big impact in terms of loss of life.

**SEARCH AND RESCUE SIZEUP (CONTINUED)**

**EXERCISE: GATHERING FACTS**

**Purpose:** This exercise is an interactive activity to give you the opportunity to consider some of the facts that CERT search and rescue teams will need to gather during sizeup.

**Instructions:** Use the following steps to complete this exercise:

1. Read Scenario 5-1 on the following page.
2. Brainstorm the following questions:
  - What does this scenario tell you about the facts that must be gathered?
  - What impact could these facts have on search and rescue operations?

---

**COMMUNITY EMERGENCY RESPONSE TEAM**  
**UNIT 5: LIGHT SEARCH AND RESCUE OPERATIONS**

---

**SCENARIO 5-1**

---

At 2:30 p.m. on Tuesday, August 9, a squall line passed through your town. Because of the difference in barometric pressure on either side of the front, the squall line was preceded by a "gust front" with straight-line winds of more than 70 miles per hour. The gust front was followed by continued strong winds and extremely heavy rain. Electricity was knocked out throughout the town.

You activate in accordance with standard operating procedures (SOPs) for CERT. On the way to the staging area at the local high school, you notice considerable damage, including felled trees and utility lines. Many streets are impassable, making you take a roundabout route to the high school. As you make your way to the staging area, you see that the roof has blown off a large portion of a local strip shopping center and that the exterior wall on the west end of the structure has collapsed.

After reaching the staging area, you check in with the Logistics Team Leader, who assigns you to Search and Rescue Team 2. Although CERT teams cannot venture into the section of the shopping center that has collapsed, Search and Rescue Team 2 will be searching near the collapsed area to see if there are victims in that area.

---

**Questions:**

1. What does this scenario tell you about the probable density for the affected area?
  
  
  
  
  
  
  
  
  
  
  
  
  
  
  
  
  
  
  
  
  
  
2. What does this scenario tell you about the facts that must be gathered?





**SCENARIO 5-1 (CONTINUED)**

3. What impact could these facts have on search and rescue operations?
  
4. What kinds of search and rescue operations are probable?
  
5. What, if any, are the constraints that search and rescue personnel may face in this scenario?
  
6. Can these constraints be overcome within the established CERT mission? If so, how?

**COMMUNITY EMERGENCY RESPONSE TEAM**  
**UNIT 5: LIGHT SEARCH AND RESCUE OPERATIONS**

**SEARCH AND RESCUE SIZEUP (CONTINUED)**

**STEP 2: ASSESS AND COMMUNICATE DAMAGE**

There are general guidelines for assessing damage. When in doubt about the condition of a building, always use the more restrictive assessment. For example, if you are unsure about whether a building is moderately or heavily damaged, assume heavy damage. The CERT mission changes depending on the amount of structural damage.

**CERT Mission by Structural Damage Category**

If Structural Damage Is . . .	Then The CERT Mission Is . . .
<b>Light:</b>	To locate, triage, and prioritize removal of victims to designated treatment areas by the medical operation teams.
<b>Moderate:</b>	To locate, stabilize, and immediately evacuate victims to a safe area while <u>minimizing the number of rescuers inside the building</u> .
<b>Heavy:</b>	To secure the building perimeter and warn others about the danger of entering the building.

Slight damage includes:

- Superficial damage.
- Broken windows.
- Fallen or cracked plaster.
- Minor damage to the interior contents.

Moderate damage includes:

- Visible signs of damage.
- Decorative work damaged or fallen.
- Many visible cracks in plaster.
- Major damage to interior content.

(Note that a moderately damaged building is still attached to the foundation.)

**SEARCH AND RESCUE SIZEUP (CONTINUED)**

Heavy damage includes:

- Partial or total collapse.
- Tilting.
- Obvious structural instability.
- Heavy smoke or fire.
- Hazardous materials inside.
- Gas leaks.
- Rising or moving water.

(Note that a heavily damaged building is not attached to the foundation.)

Do not enter a building with heavy damage under any circumstances.

Look at a building from all sides by doing a "lap around."

Communicate your findings to the CERT command post or responding agencies.

After—or in conjunction with—the damage assessment, CERT personnel must consider probable amounts of damage based on the type and age of construction. Experienced search and rescue personnel can determine probable damage to a structure based on the event and the types of structures involved.

---

**COMMUNITY EMERGENCY RESPONSE TEAM**  
**UNIT 5: LIGHT SEARCH AND RESCUE OPERATIONS**

---

**SEARCH AND RESCUE SIZEUP (CONTINUED)**

**STEP 3: CONSIDER PROBABILITIES**

Because the CERTs will be working in such close proximity to the dangerous situation, considering what will probably happen and what could happen are of critical importance. Identify potentially life-threatening hazards with an eye toward:

- How stable the situation really is. Even within a structure that appears from the outside to have only minimal or moderate damage, nonstructural damage or instability inside the structure can pose real danger to the rescue team. CERT members should think about what they already know about the structure that's been damaged. Are lawn chemicals, paints, or other potentially hazardous materials stored within the structure? How are they stored? Where are they? It won't take CERT members much time to answer these types of questions, but the answers could make a huge difference in how they approach the search.
- What else could go wrong. Based on the information gathered during steps 1 and 2 of the sizeup, CERT members should take a few moments to play "What if?" to try to identify additional risks that they may face. What if the electricity fails during the search? What if a wall that appears stable shifts and collapses? Applying "Murphy's Law" to the situation could save the CERT team's lives.
- What it all means for the search and rescue. Based on the probabilities, CERTs should think about what they can do to reduce the risks associated with the probabilities they have identified. Is a spotter necessary to look for movement that could indicate a possible collapse and warn the rescue team? Is some remedial action required to stabilize nonstructural hazards before beginning the search? CERT search and rescue teams must remember that their own safety is the first priority.

**STEP 4: ASSESS YOUR SITUATION**

Sizeup is a building process, with each step building upon the previous steps until the decision is made to begin the search and rescue operation (or that the situation is unsafe). Draw on everything you've learned from steps 1 through 3 to assess your situation to determine:

- Whether the situation is safe enough to continue.
- The risks that rescuers will face if they continue.
- What resources will be needed to conduct the operation safely (and what resources are available).

Assessing resources is extremely important to search and rescue operations.

**SEARCH AND RESCUE SIZEUP (CONTINUED)**  
**Search and Rescue Resource Planning Questions**

Resource	Planning Questions
Personnel	<ul style="list-style-type: none"><li>▪ Who lives and/or works in the area?</li><li>▪ During which hours are these people most likely to be available?</li><li>▪ What skills or hobbies do they have that might be useful in search and rescue operations?</li><li>▪ What might be the most effective means of mobilizing their efforts?</li></ul>
Equipment	<ul style="list-style-type: none"><li>▪ What equipment is available locally that might be useful for search and rescue?</li><li>▪ Where is it located?</li><li>▪ How can it be accessed?</li><li>▪ On which structures (or types of structures) might it be most effective?</li></ul>
Tools	<ul style="list-style-type: none"><li>▪ What tools are available that might be useful for lifting, moving, or cutting disaster debris?</li></ul>

**STEP 5: ESTABLISH PRIORITIES**

After evaluating the situation, the next step is to determine:

- What should be done. . .
- In what order.

The safety of CERT members is always the first priority and will dictate some of your other priorities. For example, removing or mitigating known hazards must be completed before teams begin to search. Think through the situation logically to determine how you should approach the operation.

---

**COMMUNITY EMERGENCY RESPONSE TEAM**  
**UNIT 5: LIGHT SEARCH AND RESCUE OPERATIONS**

---

**SEARCH AND RESCUE SIZEUP (CONTINUED)**

**STEP 6: MAKE DECISIONS**

You are at the point in the sizeup where you will make decisions about where to deploy your resources to do the most good, while maintaining an adequate margin of safety. Many of your decisions will be based on the priorities established during step 5. Those priorities are based on (in order):

1. The safety of CERT members.
2. Life safety for victims and others.
3. Protection of the environment.
4. Protection of property.

**STEP 7: DEVELOP PLAN OF ACTION**

Step 7 is where all of the information you have about the situation comes together. During step 7, the team leader will decide specifically how the team will conduct its operation, considering the highest priority tasks first.

Action plans do not need to be written, but, when search and rescue operations are required, the situation is probably complex enough that a written plan of some type should be developed. Even a simple written plan will:

- Help focus the operation on established priorities and decisions.
- Provide documentation to be given to responding agencies when they arrive.
- Provide documentation that can be used, if necessary, after the incident.

Keep a notebook for jotting notes when developing an action plan. These notes should include changes to the plan that are made based on new information that comes in.

**STEP 8: TAKE ACTION AND STEP 9: EVALUATE PROGRESS**

The plan developed during step 7 is put into action during step 8. Step 9, Evaluate Progress, is the most critical, not only in terms of evaluating whether the plan works, but also from a safety standpoint.

Sizeup is ongoing. Information gained during step 9 needs to be fed back into the decisionmaking process for possible revision of priorities and updated action planning.

**SEARCH AND RESCUE SIZEUP (CONTINUED)**

**SAFETY CONSIDERATIONS**

Regardless of the severity of structural damage, rescuer safety must be the primary concern.

The two most frequent causes of rescuer deaths are:

- Disorientation.
- Secondary collapse.

Follow these guidelines during all search and rescue operations:

- Use a buddy system. Always work in pairs, with a third person acting as a runner.
- Be alert for hazards (e.g., power lines, natural gas leaks, hazardous materials, sharp objects, etc.).

You should never attempt to search an area where water is present.

- Use safety equipment. Wearing gloves and a helmet will protect a rescuer's hands and head. Also, the primary cause of rescuer problems after working in a structural collapse is breathing dust, so a dust mask is essential. (However, a dust mask will not filter out harmful materials.)
- Have backup teams available to allow rotating of teams, prevent fatigue, and ensure help if a team gets into trouble. Have teams drink fluids and eat to keep themselves fresh.

Successful search and rescue depends on teamwork.

---

**COMMUNITY EMERGENCY RESPONSE TEAM**  
**UNIT 5: LIGHT SEARCH AND RESCUE OPERATIONS**

---

**SEARCH AND RESCUE SIZEUP (CONTINUED)**

**EXERCISE: SEARCH AND RESCUE SIZEUP**

**Purpose:** This exercise is an interactive activity to give you an opportunity to practice some of the thinking processes involved in planning and search and rescue sizeup. The brainstorming required will help you to begin to assess your neighborhood or workplace in terms of building structures, hazardous materials, safety precautions that need to be taken, etc. The exercise will be based on several different types of local buildings (one for each small group) for the most probable type of disaster that the community will face.

**Instructions:** Use the following steps to complete this exercise:

1. Given the disaster and the specific building assigned to your group, answer the following questions:
    - What are the pertinent facts that must be gathered?
    - What kind of prediction can you make regarding damage, based on the incident and the building construction?
    - What probable search and rescue problems can you identify?
    - What specific safety considerations can you identify?
  2. Select a spokesperson to present your group's responses to the class.
-



### CONDUCTING SEARCH OPERATIONS

When the decision is made to initiate search operations, CERT members must inspect the area assigned by the CERT Area Team Leader.

The search operation involves two processes:

1. Employing search techniques based on the sizeup
2. Locating potential victims

By using these processes, search operations will be more efficient, thorough, and safe. They will also facilitate later rescue operations.

### LOCATING POTENTIAL VICTIMS

The first step in locating potential victims is to conduct a sizeup of the situation inside the structure to gather more precise information about damage and to develop priorities and plans.

The data gathered will provide more information about areas of entrapment—or voids.

There are several types of voids:

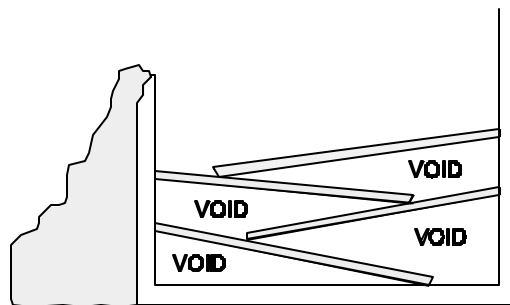

**Pancake Void**

**Pancake Void, in which floors collapse diagonally onto each other, creating voids in the areas where the floors remain attached to the walls.**

Pancake voids are most common in buildings that were constructed before 1933. They are created by weakening or destruction of load-bearing walls, which allows the floors to collapse into each other. Pancake voids are the most difficult and time-consuming to search.

Remember the dangers of unreinforced masonry structures. If CERT members see pancake voids, this is considered heavy damage, and they should get out immediately.

CONDUCTING SEARCH OPERATIONS (CONTINUED)

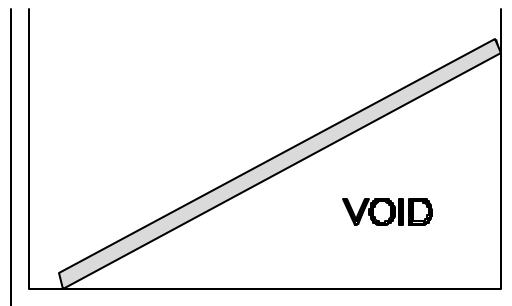

Lean-to-Void

**Lean-To Void**, in which a collapsed wall or floor leans against an outside wall, creating a void where the floor remains attached to the wall.

Lean-to voids are created when a collapsed wall or floor is resting against an outside wall. A victim trapped in a lean-to void has the greatest chance of being alive.

Lean-to voids also indicate structural instability. If CERT members see lean-to voids, they should note the location for professional responders but leave the building immediately!

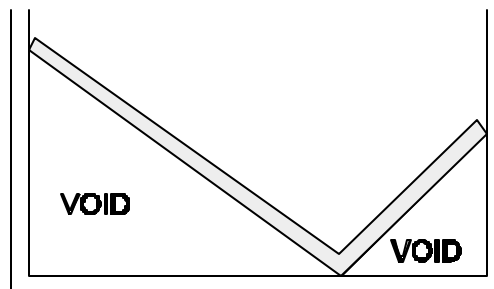

“V” Void

**“V” void**, in which the floor or wall collapses at or near the center, creating voids on either end next to the walls.

“V” voids are created by a “V” collapse of a floor or wall (the middle collapses and the ends lean against an outside wall). Remind the group that a “V” void creates two lean-to voids, one on either side of the collapse, in which victims can be trapped—but the sloping floor caused by the “V” collapse presents a severe potential hazard to the rescue team.

If CERT members encounter “V” voids, they should leave the building immediately.

Individual voids are spaces into which the victim may have crawled for protection. Examples of individual voids include bathtubs and the space underneath desks. Children may seek shelter in smaller spaces like cabinets.

**CONDUCTING SEARCH OPERATIONS (CONTINUED)**

After identifying the possible areas of entrapment, CERT members must:

- Determine the potential number of victims.
- Identify the most probable areas of entrapment.

Some of this information may be known through planning, but CERT members may need to get some information by talking to bystanders or those who are familiar with the structure.

CERT members should ask questions when talking with these individuals, including:

- How many people live (or work) in the building?
- Where would they be at this time?
- What is the building layout?
- What have you seen or heard?
- Has anyone come out?
- What are the normal exit routes from the building?

Bystanders may be confused by the event. They may tend to exaggerate potential numbers or may not even remember the event accurately. Gather as much information as you can, though, because it will be useful for planning search priorities and implementing the search.

**SEARCH METHODOLOGY**

An effective search methodology:

- Indicates rescuer location.
- Prevents duplication of effort.

**COMMUNITY EMERGENCY RESPONSE TEAM**  
**UNIT 5: LIGHT SEARCH AND RESCUE OPERATIONS**

**CONDUCTING SEARCH OPERATIONS (CONTINUED)**

Experienced search and rescue personnel have found these search methods to be effective:

1. Begin the search by calling out to victims. Shout something like, "If anyone can hear my voice, come here." If any victims respond, give them further directions such as "Stay here" or "Wait outside" (depending on the condition of the building). Ask victims who respond for any information that they may have about the building or others who may be trapped.
2. Use a systematic search pattern. Ensure that all areas of the building are covered. Examples of systematic search patterns to use include:
  - Bottom-up/top-down.
  - Right wall/left wall.

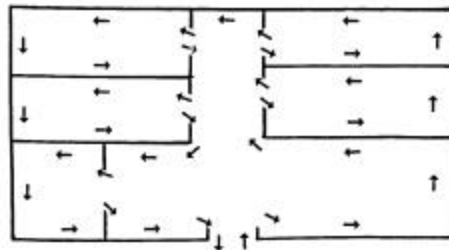

**Sample Systematic Room Search**

**Systematic Room-Search Pattern, bottom-up/top-down or right wall/left wall to ensure that the entire building is searched.**

3. Stop frequently to listen. Listen for tapping, movement, or voices.
4. Triangulate. Triangulation enables rescuers to view a single location from several perspectives. Three rescuers, guided by victim sounds, form a triangle around the area and direct flashlights into the area. The light shining from different directions will eliminate shadows that could otherwise hide victims.

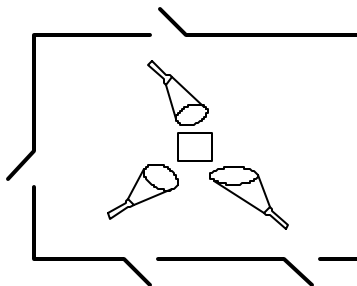

**Triangulation**

**Triangulation: Three rescuers guided by victim sounds form a triangle around the area and direct flashlights into the areas. The light will help eliminate shadows.**

### CONDUCTING SEARCH OPERATIONS (CONTINUED)

5. Mark searched areas to document results. Make a single diagonal slash next to the door just before entering a structure. Make an opposite slash (creating an "X") when all occupants have been removed and search and rescue efforts have been completed. The "X" signals to other potential searchers that the area has already been searched. This method:
- Indicates rescuer location.
  - Prevents duplication of effort.

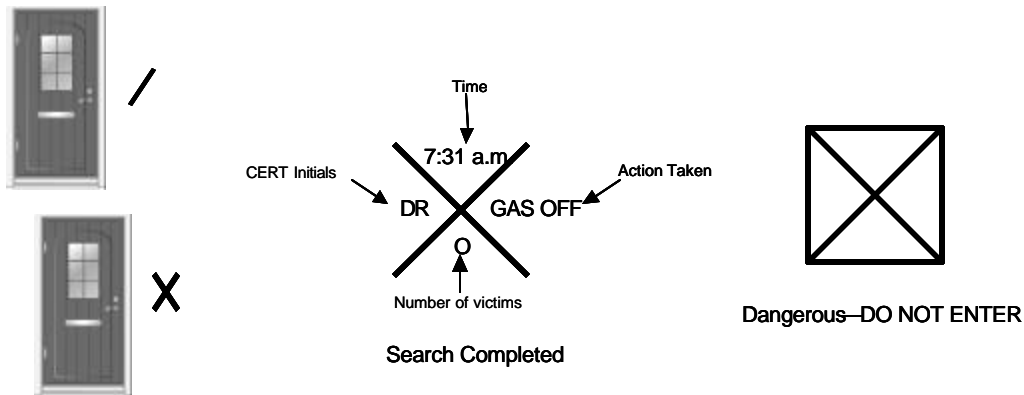

### Marking Searched Areas

6. Report results. Keep complete records both of removed victims and of victims who remain trapped or are dead. Report this information to emergency services personnel when they reach the scene.

### CONDUCTING RESCUE OPERATIONS

Rescues involve three primary functions:

- Creating a safe rescue environment by lifting objects out of the way, using tools to move objects, and removing debris.
- Triaging or stabilizing victims.
- Removing victims in a moderately damaged building. Call in the medical team in a lightly damaged building.

---

**COMMUNITY EMERGENCY RESPONSE TEAM**  
**UNIT 5: LIGHT SEARCH AND RESCUE OPERATIONS**

---

**CONDUCTING RESCUE OPERATIONS (CONTINUED)**

**CREATING A SAFE ENVIRONMENT**

There are three goals for all rescue operations:

- To maintain rescuer safety
- To triage in lightly and moderately damaged buildings
- To evacuate victims as quickly as possible from moderately damaged buildings while minimizing additional injury

None of these goals can be achieved without creating as safe an environment as possible before attempting rescue. There are, therefore, certain precautions that rescuers must take to minimize risk.

- Know your limitations. Many volunteers have been injured or killed during rescue operations because they did not pay attention to their own physical and mental limitations. CERT rescuers should take the time to eat, drink fluids, rest, and relax so that they can return with a clear mind and improved energy.
- Follow safety procedures. CERT members should always use the proper safety equipment required for the situation and follow established procedures, including:
  - Working in pairs.
  - Never entering an unstable structure.
  - Lifting by bending the knees, keeping the back straight, and pushing up with the legs.
  - Carrying the load close to the body.
  - Lifting and carrying no more than is reasonable.

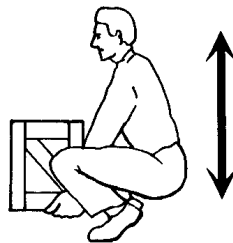

**Proper Body Position for Lifting**

**Proper Body Position for Lifting showing the back straight and lifting with the knees.**

### **CONDUCTING RESCUE OPERATIONS (CONTINUED)**

You may encounter situations in which debris needs to be moved to free victims. In these situations, CERT rescuers should consider leveraging and cribbing to move and stabilize the debris until the rescue is complete.

- Leveraging is accomplished by wedging a lever under the object that needs to be moved, with a stationary object underneath it to act as a fulcrum. When the lever is forced down over the fulcrum, the far end of the lever will lift the object.
- A crib is a wooden framework used for support or strengthening. Box cribbing means arranging pairs of wood pieces alternately to form a stable rectangle.

Leveraging and cribbing are used together by alternately lifting the object and placing cribbing materials underneath the lifted edge to stabilize it. Safety is number 1: "Lift an inch; crib an inch."

Leveraging and cribbing should be gradual—both for stability and to make the job easier. It may also be necessary to use leveraging and cribbing at more than one location (e.g., front and back) to ensure stability.

When you are able to achieve sufficient lift, remove the victim and reverse the leveraging and cribbing procedure to lower the object.

When you must remove debris to locate victims, you should set up a human chain and pass the debris from one person to the next. Set up the chain in a position that will not interfere with rescue operations. Wear leather gloves to protect your hands.

### **REMOVING VICTIMS**

There are two basic types of removal:

- Self-removal or assist
- Lifts and drags

It is usually best to allow an ambulatory victim to extricate himself or herself. However, sometimes ambulatory victims are not as strong and uninjured as they think that they are. When victims become free from entrapment, they may need assistance to exit the structure.

---

**COMMUNITY EMERGENCY RESPONSE TEAM**  
**UNIT 5: LIGHT SEARCH AND RESCUE OPERATIONS**

---

**CONDUCTING RESCUE OPERATIONS (CONTINUED)**

The type of extrication method selected should depend on the:

- General stability of the immediate environment.
- Number of rescuers available.
- Strength and ability of the rescuers.
- Condition of the victim.

If safety and time permit, you should not use lifts and drags to remove victims when closed-head or spinal injury is suspected. In such cases, the spine must be stabilized using a backboard. Doors, tables, and similar materials can be used as improvised backboards. The backboard must be able to carry the person, and proper lifting techniques must be used. When moving victims, rescuers must use teamwork and communication, and keep the victim's spine in a straight line. Remember, rescuer safety and the condition of the building will dictate the approach.

There are several types of lifts and carries. For example, if the rescuer is physically able and the victim is small, he or she may use the one-person arm carry to lift and carry the victim by:

- Reaching around the victim's back and under the knees.
- Lifting the victim while keeping the rescuer's back straight and lifting with the legs.

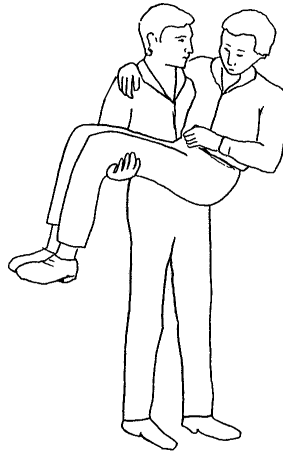

**One-Person Arm Carry**

**One-Person Arm Carry, which shows the rescuer holding the victim around the victim's back and under the knees.**

**Note:** Consider the size of the victim and the distance he or she needs to be carried before using this carry.



**CONDUCTING RESCUE OPERATIONS (CONTINUED)**

Another way for a single rescuer to lift a victim safely is by using the one-person pack-strap carry. Using this method, the rescuer should follow the steps outlined below:

- Step 1: Stand with his or her back to the victim.
- Step 2: Place the victim's arms over the rescuer's shoulders and grab the hands in front of the rescuer's chest.
- Step 3: Hoist the victim by bending forward slightly, until his or her feet just clear the floor.

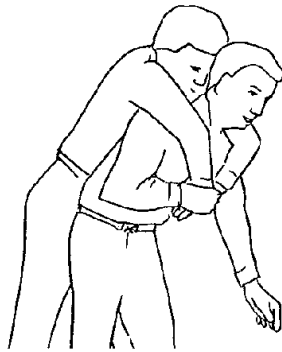

**One-Person Pack-Strap Carry**

**One-Person Pack-Strap Carry in which the rescuer places the victim's arms over his or her shoulder and grabs the victim's hands over his or her chest, then hoists the victim by bending over slightly.**

Victim removal is easier when multiple rescuers are available. With two rescuers, a victim may be removed using a two-person lift.

- Rescuer 1: Squat at the victim's head and grasp the victim from behind around the midsection. Reach under the arms and grasp the victim's forearms.
- Rescuer 2: Squat between the victim's knees, facing either toward or away from the victim. Grasp the outside of the victim's legs at the knees.
- Both rescuers: Rise to a standing position, keeping backs straight and lifting with the legs. Walk the victim to safety.

**COMMUNITY EMERGENCY RESPONSE TEAM**  
**UNIT 5: LIGHT SEARCH AND RESCUE OPERATIONS**

**CONDUCTING RESCUE OPERATIONS (CONTINUED)**

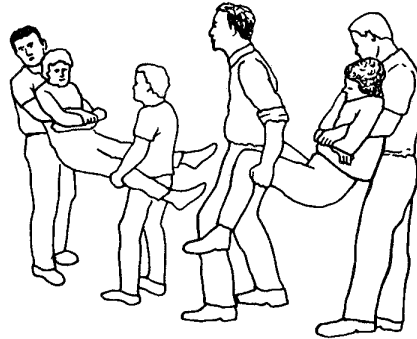

**Two-Person Carry**

**Two-Person Carry** in which rescuer 1 squats at the victim's head and grasps the victim from behind at the midsection. Rescuer 2 squats between the victim's knees, grasping the outside of the knees. Both rescuers rise to a standing position.

Two rescuers can also remove a victim by seating him or her on a chair:

- Rescuer 1: Facing the back of the chair, grasp the back uprights.
- Rescuer 2: Facing away from the victim, reach back and grasp the two front legs of the chair.
- Both rescuers: Tilt the chair back, lift, and walk out.

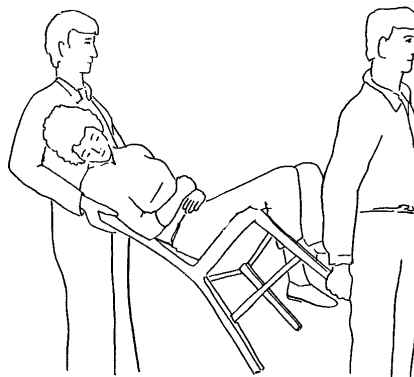

**Chair Carry**

**Chair Carry** in which the victim is placed in a chair and tilted backward as rescuers lift the victim. This carry requires two rescuers.

**CONDUCTING RESCUE OPERATIONS (CONTINUED)**

You can use the blanket carry for victims who cannot be removed by other means. The blanket carry requires at least six rescuers to ensure stability for the victim, and one rescuer must be designated the lead person:

- Step 1: Lay a blanket next to the victim.
- Step 2: Tuck the blanket under the victim, and roll the victim into the center of the blanket.
- Step 3: With three rescuers squatting on each side and grasping a “handle,” the lead person checks the team for even weight distribution and correct lifting position.
- Step 4: The lead person calls out, “Ready to lift on the count of three: One, two, three, *lift.*”
- Step 5: The team lifts and stands in unison— keeping the victim level—and carries the victim feet first.

The team must also lower the victim together, using the following steps:

- Step 1: The lead person calls out, “Ready to lower on the count of three: One, two, three, *lower.*”
- Step 2: The team lowers the victim in unison, exercising caution to keep the victim level.

A variety of materials—such as blankets—can be used as improvised stretchers.

Rescuers can also drag a victim out of a confined area by grasping either under the arms or by the feet and pulling across the floor. However, unless there is no other way to remove the victim and the victim’s removal is time critical, you should not use this drag when debris may cause additional injury.

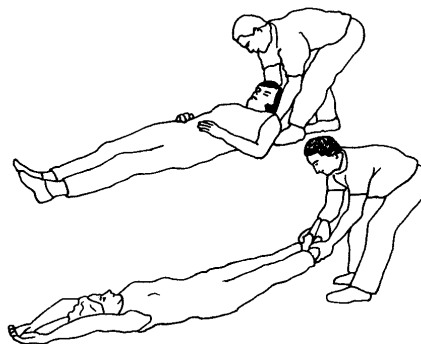

**Correct Drag Techniques**

**Correct Drag Technique, showing the rescuer grasping the victim by either the feet or shoulders and dragging him or her clear of the hazard.**

---

**COMMUNITY EMERGENCY RESPONSE TEAM**  
**UNIT 5: LIGHT SEARCH AND RESCUE OPERATIONS**

---

**CONDUCTING RESCUE OPERATIONS (CONTINUED)**

When necessary, one rescuer can use the blanket drag by following these steps:

- Step 1: Wrap the victim in a blanket.
- Step 2: Squat down and grasp an edge of the blanket.
- Step 3: Drag the victim across the floor.

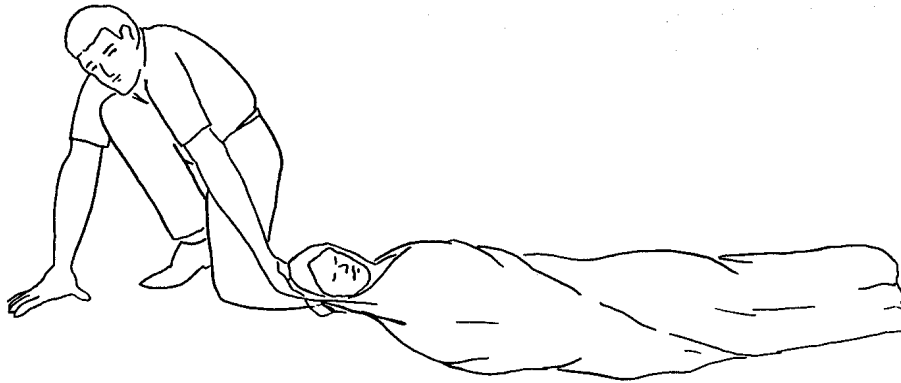

**Blanket Drag**

**Blanket Drag**, showing the victim wrapped in a blanket with the rescuer squatting at the victim's head. The rescuer grasps the blanket behind the victim's head and drags him or her clear of the hazard.

**EXERCISE: REMOVING VICTIMS**

**Purpose**: This exercise will provide you with an opportunity to practice the removal of victims from a collapse situation, using leveraging/cribbing and drags and carries. You will be assigned into groups and assigned to do a room search, locate victims, and remove the victims.

**Instructions**: Use the following steps to complete this exercise:

1. Enter your assigned "collapse site" room, do a room search, locate the victims and use leveraging and cribbing procedures to free them, and use appropriate lifts and drags to remove the victims from the room (and, if possible, from the building).
2. Rotate roles so that there are two new victims. Repeat the exercise until everyone has had an opportunity to practice being a rescuer.

### UNIT SUMMARY

Search and rescue consists of three different activities that must be planned carefully and practiced in advance. The decision to attempt a rescue should be based on:

- The risks involved.
- Achievement of the overall goal of doing the greatest good for the greatest number.

The objectives of search and rescue are to:

- Maintain rescuer safety at all times.
- Rescue the greatest number of people in the shortest amount of time.
- Rescue the lightly trapped victims first.

CERTs are restricted to light search and rescue. Their mission when dealing with heavily damaged structures or situations that are clearly unsafe (e.g., rising or swiftly-moving water) is to warn others.

Search and rescue sizeup follows the same process as does sizeup for other CERT operations. Sizeup continues throughout search and rescue efforts and provides information about how to proceed. Should sizeup indicate that evacuation is necessary, the CERT mission is to ensure safety and organization during the evacuation.

When the decision to begin search operations is made, CERT searchers must:

- Employ appropriate search techniques.
- Locate potential victims.

Locating victims means completing a size up of the building interior to identify areas of entrapment, then conducting a search that:

- Is systematic and thorough.
- Avoids unnecessary duplication of effort.
- Documents results.

---

**COMMUNITY EMERGENCY RESPONSE TEAM**  
**UNIT 5: LIGHT SEARCH AND RESCUE OPERATIONS**

---

**UNIT SUMMARY (CONTINUED)**

Rescue involves three main functions:

- Creating a safe environment
- Triaging or stabilizing victims
- Removing victims based on the sizeup

Rescue operations hinge on maintaining rescuer safety, which requires CERT members to recognize their own limitations. CERT members should *never* attempt anything that exceeds their limitations *at that point in time*.

Leveraging and cribbing may be used to remove debris and give access to trapped victims.

Victims can be removed in a number of ways, depending on:

- Their condition.
- The number of rescuers available.
- The strength and ability of the rescuers.
- The stability of the environment.

If the building's condition allows, victims with suspected head or spine injury should be stabilized on some type of backboard before being removed. If possible, these removals should be deferred to trained EMS personnel.

**HOMEWORK ASSIGNMENT**

Read and become familiar with Unit 6: CERT Organization and Unit 7: Disaster Psychology before the next session.

---

---

## UNIT 5: ADDITIONAL MATERIALS

---

---

---





**LEVERAGING/CRIBBING OPERATION**

1. Conduct a sizeup of the scene: Gather facts, identify hazards, and establish priorities.
  2. Have one person in charge and formulate a plan of action based upon the information you have received. Identify how and where to lift and crib.
  3. Gather necessary materials for lifting/cribbing operations:
    - Lever
    - Fulcrum
    - Cribbing blocks
    - Spacers/wedges
  4. Use cribbing materials to stabilize the object prior to lifting. (Set the foundation of the box crib.)
  5. Distribute crib materials as necessary to be readily accessible during the lifting operation.
  6. Prepare to lift the object: Assemble the lever and fulcrum at the previously identified location.
  7. Have someone available to handle the victim.
  8. Initiate the lift, using the lever and fulcrum for mechanical advantage.
  9. As the object is lifted, add cribbing as needed; build on the foundation of the box crib.
  10. When the object is adequately supported, remove the lever and fulcrum. The victim may then be removed.
  11. Reinitiate the lift and begin removing cribbing materials, reversing the process by which the crib was built.
  12. Progressively lower the object to the ground.
  13. Reassemble the lifting/cribbing supplies to be available for additional operations.
-

---

**COMMUNITY EMERGENCY RESPONSE TEAM**  
**UNIT 5: LIGHT SEARCH AND RESCUE OPERATIONS**

---

**ARRANGEMENT FOR LEVERAGING/CRIBBING OPERATION**

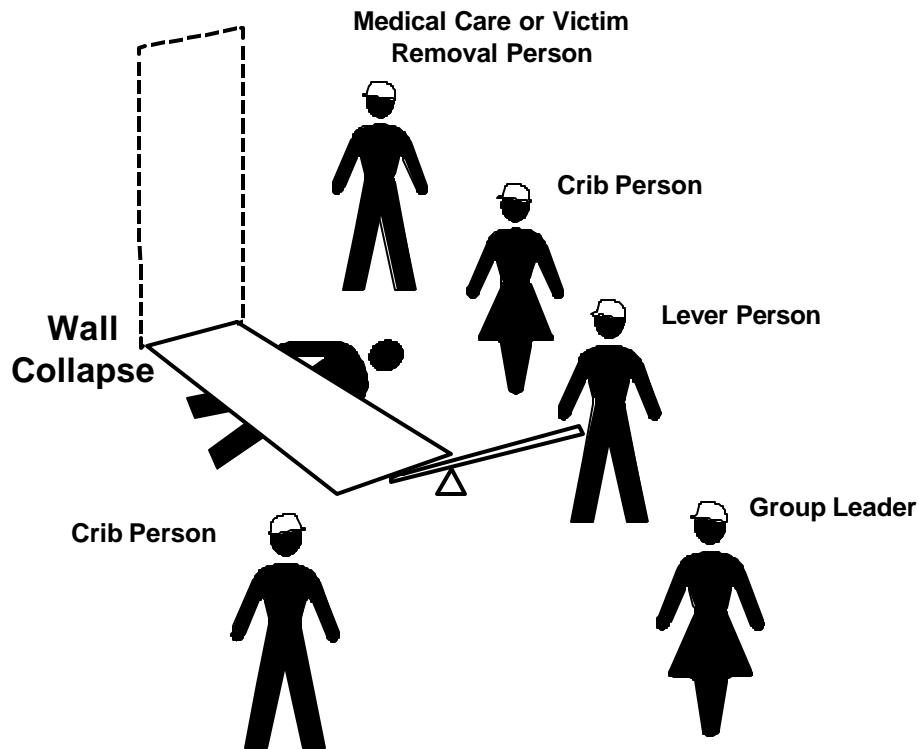

Team Organization for Leveraging/Cribbing Operation, showing the victim underneath a collapsed wall and the CERT members at the following locations:

- **Group Leader:** In front of collapse, positioned so that he or she can view the entire operation while remaining out of the rescuers' way.
- **Lever Person:** At the front edge of the collapsed wall and positioned so that he or she can position a fulcrum and lever under the wall.
- **Crib Persons:** On either side of the collapsed wall and positioned to enable the placement of cribbing as the wall is raised with the lever.
- **Medical Care/Victim Removal Person:** Next to the Crib Person who is closest to the victim's head.

### BOX CRIBBING

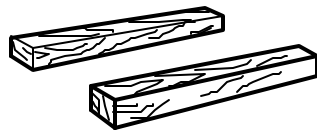
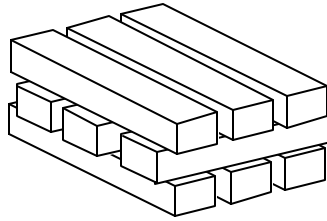

Step 1

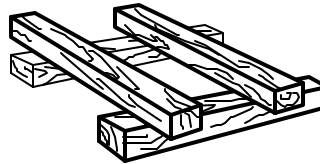

Step 2

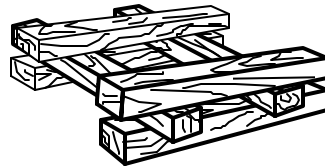

Step 3

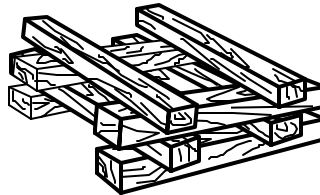

Step 4

Four steps for building box cribbing: Step 1: Position two pieces of wood parallel to each other on either side of the collapse. Step 2: Place two pieces of wood perpendicularly across the base pieces. Steps 3 and 4: Add additional layers of wood, with each perpendicular to the previous level.

**COMMUNITY EMERGENCY RESPONSE TEAM**  
**UNIT 5: LIGHT SEARCH AND RESCUE OPERATIONS**

**PROBABLE SEVERITY AND TYPE OF EARTHQUAKE DAMAGE BASED ON CONSTRUCTION TYPE**

<b>Construction Type</b>	<b>Description</b>	<b>Probable Damage Areas</b>	<b>Severity</b>
Single-Family Dwelling	<ul style="list-style-type: none"> <li>▪ Wood frame</li> </ul>	<ul style="list-style-type: none"> <li>▪ Masonry chimney</li> <li>▪ Utilities</li> </ul>	Light
	<ul style="list-style-type: none"> <li>▪ Pre-1933</li> </ul>	<ul style="list-style-type: none"> <li>▪ Foundation movement</li> <li>▪ Utilities</li> <li>▪ Porches</li> </ul>	Moderate
	<ul style="list-style-type: none"> <li>▪ Hillside</li> </ul>	<ul style="list-style-type: none"> <li>▪ Unique hazards</li> <li>▪ Ground failure</li> </ul>	Heavy
Multiple-Family Dwelling	<ul style="list-style-type: none"> <li>▪ Up-and-down and/or side-by-side living units</li> </ul>	<ul style="list-style-type: none"> <li>▪ Soft first floor</li> <li>▪ Utilities</li> </ul>	Moderate
Unreinforced Brick	<ul style="list-style-type: none"> <li>▪ Pre-1933 construction</li> <li>▪ Lime or sand mortar</li> <li>▪ "King Row" or "Soldier Row" (bricks turned on edge every 5-7 rows)</li> <li>▪ Reinforcing plates</li> </ul>	<ul style="list-style-type: none"> <li>▪ Arched/recessed windows and doors</li> <li>▪ Walls collapse, then roof</li> </ul>	Heavy
Tilt-Up	<ul style="list-style-type: none"> <li>▪ Large warehouses and plants</li> <li>▪ Concrete slabs lifted into place</li> <li>▪ Walls inset approximately 6-8 inches</li> <li>▪ Lightweight roof construction</li> </ul>	<ul style="list-style-type: none"> <li>▪ Roof collapses, then walls</li> </ul>	Heavy
High-Rise	<ul style="list-style-type: none"> <li>▪ Steel reinforced</li> </ul>	<ul style="list-style-type: none"> <li>▪ Broken glass</li> <li>▪ Content movement</li> <li>▪ Exterior trim/fascia</li> </ul>	Light

---

# UNIT 6: CERT ORGANIZATION

---

---

**In this unit you will learn about:**

- **CERT Organization:** How to organize and deploy volunteer resources according to CERT organizational principles.
- **Rescuer Safety:** How to protect your own safety and your buddy's during search and rescue.
- **Documentation:** Strategies for documenting situation and resource status.
- **Team Organization:** A tabletop exercise will give you the opportunity to apply your knowledge of team organization.



UNIT 6: CERT ORGANIZATION

---

**INTRODUCTION AND UNIT OVERVIEW**

In previous units, you learned specific strategies and tasks to use in specific situations. In this unit, you will use that knowledge in a team environment, using the CERT organization as a foundation.

**OBJECTIVES**

At the end of this unit, you should be able to:

- Describe the CERT organization.
  - Identify how CERTs interrelate with ICS.
  - Explain CERT documentation requirements.
- 

**CERT ORGANIZATION**

Emergency on-scene management in a disaster situation is needed to:

- Maintain the safety of disaster workers. CERT Incident Commanders must continually prioritize response activities based on the team's capability and training and the principle that rescuer safety is the number-one concern. CERT functional leadership assigns activities and accounts for team members. CERT team members work in the buddy system and respond based on their sizeup of the situations that they encounter.
- Provide clear leadership and organizational structure by developing a chain of command and roles that are known by all team members. Each CERT member has only one person that he or she takes direction from and responds to.
- Improve the effectiveness of rescue efforts. Disaster information is collected and responses are prioritized based on rescuer safety and doing the greatest good for the greatest number according to the team's capabilities and training.

**NEED FOR CERT ORGANIZATION**

The specific CERT organizational structure now in use provides:

- Common terminology that contributes to effective communication and shared understanding.
- Effective communication among team members.

**CERT ORGANIZATION (CONTINUED)**

- A well-defined management structure (e.g., leadership, functional areas, reporting chain, working in teams).
- Accountability.

The CERT organization fulfills these requirements, and also has the advantage of:

- Common terminology that contributes to effective communication and shared understanding.
- Consolidated action plans that coordinate strategic goals, tactical objectives, and support activities.
- Comprehensive resource management that facilitates application of available resources to the right incident in a timely manner.
- A manageable span of control that provides for a desirable rescuer/supervisor ratio of between three and seven rescuers per supervisor.

**OBJECTIVES OF CERT ORGANIZATION**

In a disaster situation, CERT organization:

- Identifies the scope of the incident. (What is the problem?)
- Determines an overall strategy. (What can we do, and how will we do it?)
- Deploys teams and resources. (Who is going to do what?)
- Documents actions and results.

CERT organizational framework is flexible, so that it can expand or contract depending on the on-going assessment priorities determined by the IC, and people and resources available. This expansion and contraction helps ensure rescuer safety, doing the greatest good for the greatest number, manageable span of control and accountability of CERT members.



**CERT ORGANIZATION (CONTINUED)**

**INCIDENT COMMAND SYSTEM**

The Incident Command System (ICS) is the system used by fire and law enforcement agencies to manage emergency operations. When CERTs activate for their neighborhood or workplace they become part of that system. CERTs interrelate with ICS:

- CERTs are part of ICS.
- All CERTs, through their Incident Commanders, report to the first fire or law enforcement official at their location and take directions from that person until told that the command system has changed, or until relieved.

The basic ICS structure is established by the person who arrives first to the scene, who becomes the Incident Commander. Initially, the Incident Commander may handle all of the command positions shown in the visual, but as the incident evolves, may assign personnel as the:

- Operations Section Chief.
- Logistics Section Chief.
- Planning Section Chief.
- Administration Section Chief.

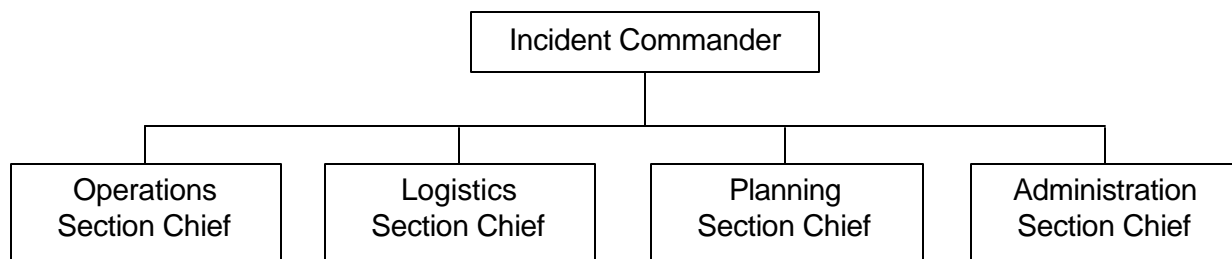

**ICS Command Function Organization Chart**

**ICS Command Function Organization Chart, showing the Incident Commander at the top and the four Section Chiefs (i.e., Operations, Logistics, Planning, and Admin) reporting to the Incident Commander.**

As the incident expands, it may be necessary to assign other personnel in each section to handle specific aspects of the response while maintaining an effective span of control.

**CERT ORGANIZATION (CONTINUED)****CERT STRUCTURE**

The following points about CERT structure are important:

- Each CERT must establish a command structure.
- A CERT Leader—or, in ICS terms, Incident Commander—is appointed to direct team activities. For CERT volunteer activities and training, this person may be appointed. However, during activation for a disaster, this person is the first to arrive at a pre-designated staging area.
- The location established by the CERT Leader as the central point for command and control of the incident is called the Command Post for the CERT. The IC stays in the command post. If the IC has to leave, the responsibility of IC must be delegated to someone in the command post.
- The CERT Leader may appoint members to assist with managing resources, services, and supplies (logistics). CERT Leaders may also appoint members to collect and display information (planning/intelligence) and collect and compile documentation. To maintain span of control, this delegation occurs as the organization expands.
- The CERT may operate as a single team that performs all activities as required, or may be divided into smaller teams (under Operations) of at least three people to achieve specific goals developed by the IC (e.g., fire suppression, medical, search and rescue), with a leader for each.
- In all situations, each unit assigned must have an identified leader to supervise tasks being performed to account for team members, and to report information to his or her designated leader.

CERT personnel should always be assigned to teams consisting of at least three persons:

- One person will serve as a runner and communicate with the Command Post.
- Two people will “buddy up” to respond to the immediate needs.

The Logistics and Planning Sections may be expanded in the same way with:

- Logistics including Service and Support units.
- Planning including Situation and Status units.

**CERT ORGANIZATION (CONTINUED)**

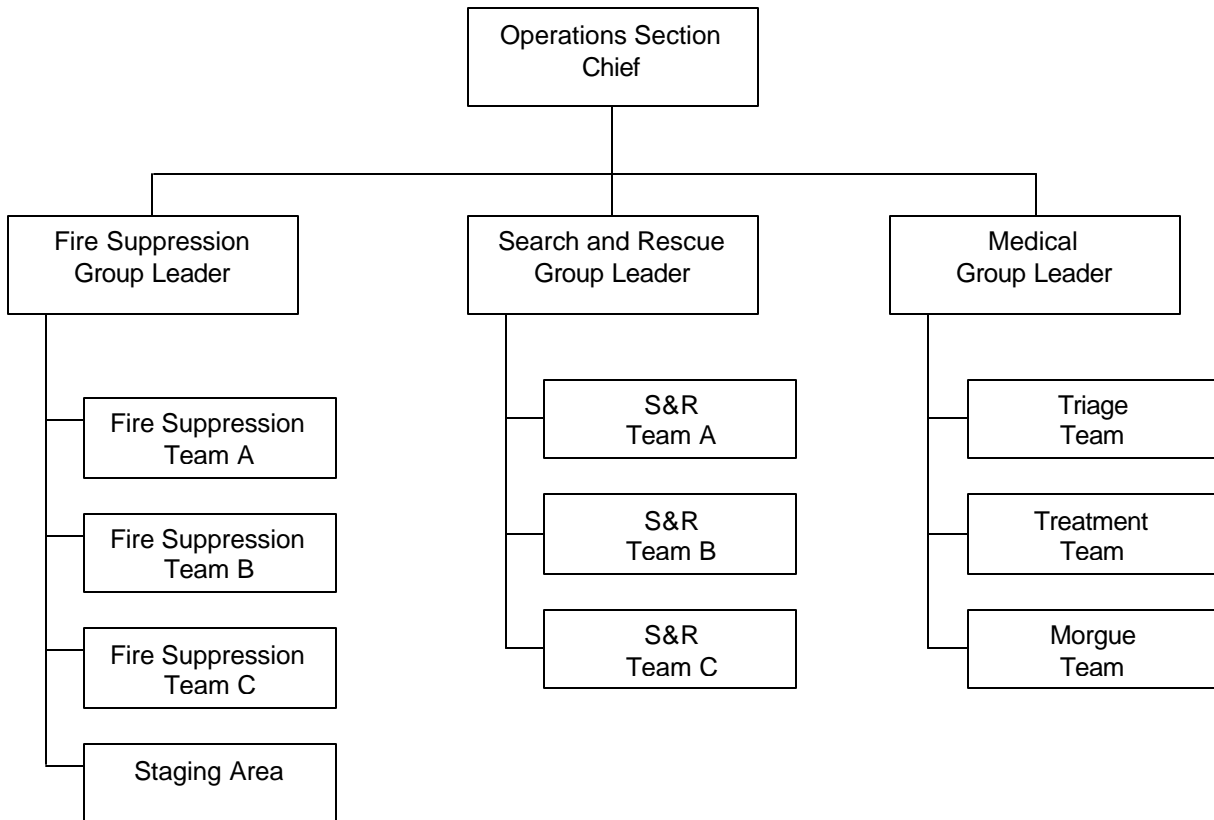

**CERT Operations Section Structure**

**CERT Operations Section Structure, showing the Operations Section Chief at the top and the three Group Leaders underneath (Fire Suppression, Search and Rescue, and Medical). Reporting to the Fire Suppression Group Leader are all fire suppression teams and the Staging Area. Reporting to the Search and Rescue Team Leader are all search and rescue teams. Reporting to the Medical Group Leader are the Triage Team, the Treatment Team, and the Morgue Team.**

---

**CERT DECISIONMAKING****CERT MOBILIZATION**

CERT organization proceeds in the following way after an incident:

- Following the incident, CERT members take care of themselves, their families, their homes, and their neighbors.
- If the SOP calls for self-activation, CERT members proceed to the pre-designated staging area with their disaster supplies. Along the way, they make damage assessments that would be helpful for the CERT IC's decisionmaking.
- The first CERT member at the staging area becomes the initial IC for the response. As other CERT members arrive, the CERT IC may pass leadership to someone more qualified. Otherwise, the CERT IC develops the organization to ensure effective communication, to maintain span of control, maintain accountability, and do the greatest good for the greatest number without placing CERT members in harm's way.
- As intelligence is collected and assessed (from CERT members reporting to the staging area, emergency volunteers, and reports from working teams [e.g., search and rescue] by the planning function, the IC must prioritize actions and work with the Section Chiefs or leaders). The CERT organization is flexible and evolves based on new information.

Following an incident, information—and, therefore, priorities—may be changing rapidly. Communication between the IC and response teams ensures that CERTs do not overextend their resources or supplies.

**RESCUER SAFETY**

Effective emergency scene management requires the formulation and communication of strategic goals and tactical objectives that are based primarily on the safety of rescue personnel.

Rescuer safety is paramount. The question, "Is it safe for the CERT members to attempt the rescue?" is primary. The answer to this question is based mainly on the degree of damage to the structure.

**CERT DECISIONMAKING (CONTINUED)**

**CERT Rescue Efforts Based On Degree Of Damage**

Degree Of Damage	Should Rescue Be Attempted?
Heavy	No. Too dangerous to enter. Warn people to stay away.
Moderate	Yes, but perform only quick and safe removals; limit onsite medical care to checking for breathing, stopping major bleeding, and treating for shock. Minimize the number of rescuers inside the building.
Light	Yes. Locate, triage, and prioritize removal of victims to the designated treatment area.

**Strategies For Damaged Structures**

Light	Moderate	Heavy
<i>Superficial damage, broken windows, fallen plaster, major damage is to contents of building</i>	<i>Visible signs of minor structural damage; decorative work that is damaged or fallen; many visible cracks in plaster; building still attached to foundation; major damage is to contents of building</i>	<i>Partial or total collapse of walls and/or ceilings; obvious structural instability; tilting; off foundation; heavy smoke or fire; gas leaks; hazardous materials inside; rising or moving water</i>
<ol style="list-style-type: none"> <li>Secure building utilities (as needed).</li> <li>Establish and coordinate search and rescue teams with medical triage personnel.</li> <li>Establish "I" and "D" treatment areas.</li> <li><b>Primary Mission:</b> Locate, triage, and prioritize removal of victims to designated treatment area.</li> <li>Continue evacuation process until all victims have been removed and accounted for.</li> <li>Reassess structural stability and available resources for heavy rescue problems. Communicate and document location of trapped and/or missing persons to emergency personnel.</li> </ol>	<ol style="list-style-type: none"> <li>Secure building utilities (gas, electrical, water).</li> <li>Gather information (victim locations).</li> <li>Establish control person at exit and entry points.</li> <li>Establish and coordinate two- to four-person rescue teams.</li> <li><b>Primary Mission:</b> Locate, stabilize, and immediately evacuate victims to a safe area while minimizing the number of rescuers inside the building.</li> <li>Perform triage and other medical care in a safe area.</li> <li>Continue rescuing lightly trapped victims until complete or no longer safe.</li> <li>Continue sizeup.</li> <li>Communicate and document the location of heavily trapped or deceased victims.</li> </ol>	<ol style="list-style-type: none"> <li>Communicate the location and extent of damage to emergency services personnel.</li> <li>Secure building perimeter and warn untrained and well-intentioned volunteers about danger and entry into building.</li> <li>From the exterior of the building, attempt to shut off gas (if it is possible and safe to do so).</li> <li>Gather available information from survivors or witnesses for professional rescue teams.</li> </ol>

---

## COMMUNITY EMERGENCY RESPONSE TEAM

### UNIT 6: CERT ORGANIZATION

---

#### CERT DECISIONMAKING (CONTINUED)

The extent of involvement for the various CERT functional teams varies depending on the level of damage encountered.

##### Light Damage

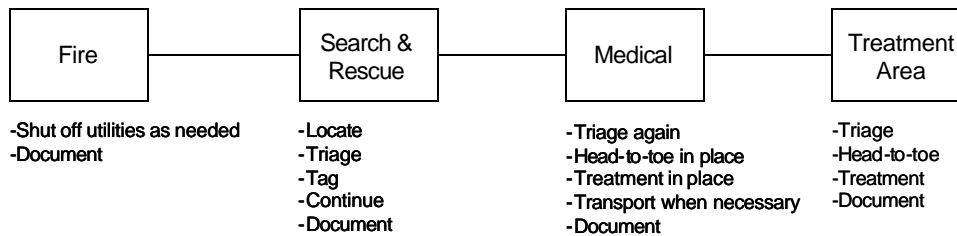

##### Moderate Damage

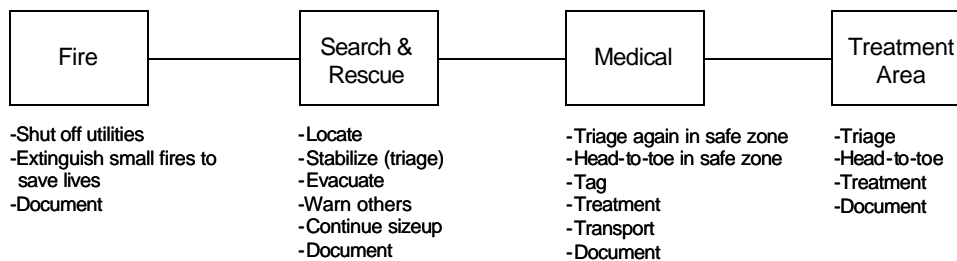

##### Heavy Damage

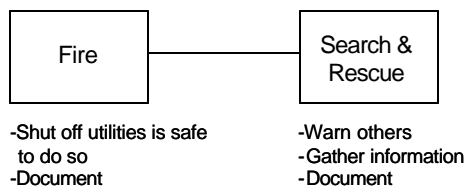

#### Team Tasks Based On Damage Level

Tasks required of Fire, Search and Rescue, Medical, and Treatment Area teams based on the degree of damage to the structure.

---

### **DOCUMENTATION**

It is vital to document and communicate information about the disaster situation and resource status. Efficient flow of information makes it possible for resources to be deployed effectively and for professional emergency services to be applied appropriately.

Under the CERT organization, each level of authority has documentation responsibilities:

- Section Chiefs are responsible for providing the Command Post with ongoing information about damage assessment, group status, and ongoing needs.
- The Command Post is responsible for documenting the situation status, including:
  - Incident locations.
  - Access routes.
  - Identified hazards.
  - Support locations.

Note that support locations include the:

- Staging area.
- Medical treatment and triage area.
- Morgue, if there are fatalities.

This documentation must be provided to the first professional responders on the scene.

This information is vital for tracking the overall situation.

### **FORMS FOR DOCUMENTATION**

There are several standard forms that can be used to facilitate documentation and information flow.

**COMMUNITY EMERGENCY RESPONSE TEAM**

**UNIT 6: CERT ORGANIZATION**

**Damage Assessment**

<b>Date:</b> 10/20/01	<b>Person Reporting:</b> Joe Montana	<b>Page #:</b> 1
<b>Time Received:</b> 9:50	<b>Person Receiving:</b> Jim Harkins	

		Burning	Out	Gas Lead	H2O Lead	Electric	Chemical	Damage*	Collapsed	Injured	Trapped	Dead	Access	No Access	Assignment Completed
Time	Location/Address	Fires		Hazards			Structures	People			Roads		/X		
9:45	13267 Magnolia				X	X		M							X

FOR USE BY EVERYONE www.cert-la.com 10/08/01

Summary of all hazards in area - fill out this form on your way to Command Post and give it to Incident Command.  
 (\* for structure damage: h=heavy, m=moderate, l=light)  
 Incident Command: Choose an incident, put a slash in the assignment completed column, copy the address/location to the incident name section on Incident Briefing, and give Incident Briefing and Assignment Status to incident team leader. Copy address/location to Post-Incident Status and enter start time. When incident is complete, put a backlash in the assignment completed column and the incident end time on the Post-Incident Status form.



**COMMUNITY EMERGENCY RESPONSE TEAM**

**UNIT 6: CERT ORGANIZATION**



**Personnel Resources**

Date: 10/20/01		Person Reporting: Mary Smith				Page #: 1		
Print Name and Time In			Skill Specialty Rank From 1-5 or Print "No"					
Name	Time In	Time Assigned	Fire	Medical	S&R	Transport	Document	Other
Mary Smith	9:15	9:15						Personnel & Equipment Mgr.
Jim Harkins	9:15	9:15						Incident Commander
<del>Jerry Rice</del>	9:32	10:05	X	X	no	3	no	
Frank Thomas	9:35	10:00	2	3	X	4	no	
<del>J.J. Stokes</del>	9:43	10:05	X	X	4	3	no	radio
Babe Ruth	9:45	10:00	3	2	X	4	5	
Steve Young	9:50	10:00	X	X	3	4	5	
Mark McGwire	9:50	10:00	1	no	X	3	no	
Willie Mays	9:50	10:00	2	3	X	4	5	
<del>Joe Montana</del>	9:52	10:05	X	X	4	5	3	
Lou Gehrig	9:55	10:00	1	no	X	3	no	
Serena Williams	9:58	10:03	1	2	3	no	X	heavy equipment
Sammy Sosa	10:03	10:03	3	2	1	5	4	to Treatment Area
Leah Malot	10:11		2	3	1	4	5	catering truck
Gete Wami	10:19		1	3	2	5	4	
Jerry Rice	12:00		2	1	4	3	no	radio

FOR USE BY LOGISTICS AND STAGING

www.cert-la.com

10/08/01

Have people sign in and mark their special skills. When you assign someone to a team, circle that team's box next to their name and enter the time assigned. When someone returns from an assignment, draw a line through their name and all boxes and have the person sign in again. Remember to check how long people have been assigned and who hasn't been assigned yet.

**COMMUNITY EMERGENCY RESPONSE TEAM**

**UNIT 6: CERT ORGANIZATION**

**Equipment Resources**

<b>Date:</b> 10/20/01	<b>Person Reporting:</b> Mary Smith	<b>Page #:</b> 1
-----------------------	-------------------------------------	------------------

		Fire Extinguisher	Wrench	Flashlight	First Aid Kit	Blankets	Stretchers				
<b>Time:</b>	<b>Loaned To:</b>										
9:15		+4	+6	+7	+2	+1	2				
10:05	to Willie Mays			-2							
10:05	to Frank Thomas		-1	-2							
10:06	to Joe Montana	-2		-1	-1	-2	-1				
10:10	Balance	2	5	2	1	8					
10:55	from Joe Montana	+2		+1	+1		+1				
11:00	Balance	4	5	3	2	8	1				

Enter equipment and supplies as they come in and out. Total periodically.  
 If an item is returned empty (for instance, a fire extinguisher), add it back in and circle the number, so you don't include it in your next total.

COMMUNITY EMERGENCY RESPONSE TEAM

UNIT 6: CERT ORGANIZATION

Incident Briefing

Prepared By: Jim Harkins

Date: 10/20/01

Time: 9:50

Incident Name: 13267 Magnolia

Map Sketch:

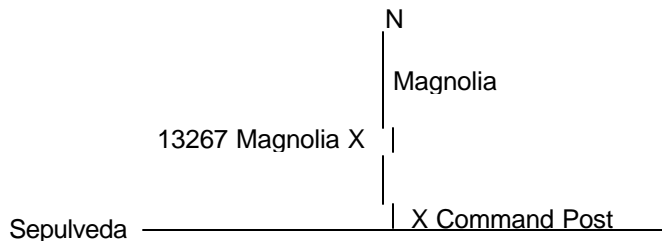

Current Organization:

Incident Commander: Jim Harkins

Battalion: 8

Summary of Current Actions

**Be aware of hazards! Work as a team!**

Gas, electricity, water shut off.

Found and removed 6 victims.  
1 dead inside.

Treated 1 minor, 3 delayed and 2 immediate.

Transported 6 victims to treatment area,  
then transported 3 victims to Kaiser Hospital.

FOR INCIDENT COMMANDER

[www.cert-la.com](http://www.cert-la.com)

10/08/01

Incident Command: Transfer an incident from Damage Assessment sheet. Sketch a map of the incident area, if known, with any hazards. Enter Incident Commander's name and Battalion number under current organization. Give to incident team leader with Assignment Status sheet.

Incident team leader: Sketch a map of the incident area with any hazards, if not done by Incident Command. Summarize the actions of your teams. When incident is complete, return this form, along with Assignment Status, to Incident Command.

**COMMUNITY EMERGENCY RESPONSE TEAM**  
**UNIT 6: CERT ORGANIZATION**

**Message Form**

<b>To:</b> Logistics	Message Center Use Only Incident: <u>13267 Magnolia</u> Time: _____ Date: <u>10/20/01</u> <input type="checkbox"/> Incoming <input type="checkbox"/> Outgoing
<b>From:</b> S&R 1	
<b>Time:</b> 10:40	
<b>Message Text:</b>	
Found one person trapped.	
Need 2 prybars and enough cribbing for 2 supports, each 2 feet high	
<b>Action Taken:</b>	
Running short of cribbing.	
Am sending 2 prybars and 18" of cribbing, procuring more	

USE CLEAR CONCISE TEXT

www.cert-la.com 10/08/01

Examples: assignment completed, additional resources needed, unable to complete, special information/status update.

**COMMUNITY EMERGENCY RESPONSE TEAM**

**UNIT 6: CERT ORGANIZATION**

**Incident Status**

<b>Date:</b>	<b>Person Reporting:</b>		<b>Page:</b>
<b>Address/Location</b>	<b>Assignment</b>	<b>Start Time</b>	<b>End Time</b>
8203 Sepulveda	Mary Smith	9:15	10:25
8203 Sepulveda	Jim Harkins	9:15	10:25
7212 Sepulveda	Frank Thomas	10:00	
7212 Sepulveda	Babe Ruth	10:00	
7212 Sepulveda	Steve Young	10:00	

FOR INCIDENT COMMAND

[www.cert-la.com](http://www.cert-la.com)

10/08/01

Record incident assignments from Damage Assessment sheets. When incident is complete, enter end time and make a backslash for that incident on the Damage Assessment.

COMMUNITY EMERGENCY RESPONSE TEAM

UNIT 6: CERT ORGANIZATION

Victim Treatment Area Record

Date: 10/20/01		Person Reporting: Rich Richins			Page #:	
Time In:	Name or Descriptive	Triage Tag	Condition	Moved To:	Time Out	
10:19	Rich Richins	D	Minor cut on forehead			
10:35	White male, about 45 years, balding, overweight	I	Deep cut on right thigh, unconscious, shock			
10:52	Willard Scott	D	Broken left arm, swollen left ankle	Kaiser	12:08	
11:15	White female, blond, late 20's, pregnant	I	Unconscious, shallow breathing, shock	Kaiser	12:08	
11:20	White female, 60s, "Annie"	I	Disoriented, large bump on forehead, shock	Kaiser	12:08	
11:47	Jill Johns	D	Minor cuts and bruises, shock			

10/08/01

[www.certia.com](http://www.certia.com)

FOR MEDICAL TREATMENT AREA

Document each person brought to the treatment area.  
 If Victim Cannot Give Name, Write a Brief Description (e.g., Sex, Approximate Age, Hair Color, Race, etc).  
 Tag color: red=Immediate, yellow=Delayed, green=Minor, Black=Dead

**DOCUMENTATION (CONTINUED)****Forms Used For Response Documentation**

<b>Form</b>	<b>Purpose</b>
Damage Assessment Survey	<ul style="list-style-type: none"><li>▪ Completed by CERT leaders. Provides a summary of overall hazards in selected areas, including:<ul style="list-style-type: none"><li>• Fires.</li><li>• Utility hazards.</li><li>• Structural damage.</li><li>• Injuries and casualties.</li><li>• Available access.</li></ul></li><li>▪ Essential for prioritizing and formulating action plans.</li></ul>
Personnel Resources Form	<ul style="list-style-type: none"><li>▪ Completed by CERT members as they arrive at the Staging Area. Provides information about:<ul style="list-style-type: none"><li>• Who is on site.</li><li>• When they arrived.</li><li>• When they were assigned.</li><li>• Their special skills.</li></ul></li><li>▪ Used by Staging personnel to track personnel availability.</li></ul>
Equipment Resources Form	<ul style="list-style-type: none"><li>▪ Completed by Logistics and Staging Area personnel to track the loan of equipment to CERT members.</li></ul>
Incident Briefing	<ul style="list-style-type: none"><li>▪ Completed by the Incident Commander (Team Leader) to identify damage, known hazards, and actions taken.</li></ul>
Message Form	<ul style="list-style-type: none"><li>▪ Used for sending messages between command levels and groups. Messages should be clear and concise and should focus on such key issues as:<ul style="list-style-type: none"><li>• Assignment completion.</li><li>• Additional resources required.</li><li>• Special information.</li><li>• Status update.</li></ul></li></ul>
Incident Status Record	<ul style="list-style-type: none"><li>▪ Used by the command post for keeping abreast of situation status. Contains essential information for tracking personnel assignments.</li></ul>
Victim Treatment Area Record	<ul style="list-style-type: none"><li>▪ Completed by Medical Treatment Area personnel to record victims entering the treatment area, their condition, and their status.</li></ul>

**DOCUMENTATION (CONTINUED)****ACTIVITY: ICS FUNCTIONS****Instructions:**

Using your knowledge about the five ICS functions, decide under which function the following activities would fall. Some activities may involve more than one function to be completed.

Use the following key to fill in the blanks before each activity:

IC = Incident Commander

O = Operations

P = Planning

L = Logistics

- \_\_\_\_\_ 1. It's dark, all the lights are out, you need additional flashlights to continue your response.
  - \_\_\_\_\_ 2. The designated first aid site has a downed power line.
  - \_\_\_\_\_ 3. A neighbor reports the smell of gas in his house, but he cannot shut off the gas at the meter.
  - \_\_\_\_\_ 4. The batteries for the portable radio are dead.
  - \_\_\_\_\_ 5. The City wants to know the overall status of your neighborhood.
  - \_\_\_\_\_ 6. Several of your neighbors have minor injuries and need first aid.
  - \_\_\_\_\_ 7. Fire from another neighborhood is moving toward your neighborhood.
  - \_\_\_\_\_ 8. There is a pit bull-type dog seen wandering near the first aid station.
  - \_\_\_\_\_ 9. A news crew has arrived with a camera to film your activities.
  - \_\_\_\_\_ 10. Two hysterical neighbors are demanding help. One cannot find her adolescent child who was playing outside when the disaster struck. The other wants help moving a bookcase off of his wife. He says she's bleeding from a wound on the head.
  - \_\_\_\_\_ 11. It's starting to rain. Your command post and the first aid area are not under shelter.
  - \_\_\_\_\_ 12. Too many people are coming to the Incident Commander to ask questions. The IC asks for someone to act as a "gatekeeper."
  - \_\_\_\_\_ 13. There is a great increase of car and foot traffic through your neighborhood because other roadways are blocked
  - \_\_\_\_\_ 14. The Incident Commander is very tired and is going to hand over responsibilities to someone else. She wants a report on the status of the neighborhood before doing so.
  - \_\_\_\_\_ 15. Many neighborhood residents have come to volunteer their help.
  - \_\_\_\_\_ 16. Reports have come in of damage and injuries in the next block. Teams must be assigned to assess the situation.
  - \_\_\_\_\_ 17. A professional responder has arrived at the scene and would like a briefing on situation status.
-



**TABLETOP EXERCISE**

**Purpose:** This exercise is an interactive tabletop activity that gives you an opportunity to apply what you have learned about team organization.

**Instructions:** To complete this exercise, follow these steps:

1. Work in your table group.
2. Read the scenario distributed by the Instructor.

Remember that CERT command objectives are to:

- Identify the scope of the incident.
- Determine an overall CERT strategy.
- Set priorities and deploy resources.

3. You will have 30 minutes to complete the exercise.
-

**UNIT SUMMARY**

The ICS concept has proven emergency in disaster response. ICS provides a flexible means of controlling personnel, facilities, equipment, and communication and can be expanded as necessary. Its principles are used as the basis of the CERT organization.

The key question that CERT leaders must always ask is: *“Is it safe for CERT members to attempt the rescue?”* Whether or not to attempt a rescue depends on the degree of damage to the structure involved.

It is vital to document and communicate information about situation and resource status to all CERT levels.

- Response teams and their functional groups must provide the command post with ongoing information about damage assessment, group status, and ongoing needs.
  - The command post must document the situation status so that the overall disaster situation can be tracked.
-

---

## APPENDIX 6-A: CERT FORMS

---

---

---



**COMMUNITY EMERGENCY RESPONSE TEAM  
CERT FORMS**



**Damage Assessment**

<b>Date:</b>	<b>Person Reporting:</b>	<b>Page #:</b>
<b>Time Received:</b>	<b>Person Receiving:</b>	

		Burning	Out	Gas Lead	H2O Lead	Electric	Chemical	Damage*	Collapsed	Injured	Trapped	Dead	Access	No Access	Assignment Completed
Time	Location/Address	Fires				Hazards		Structures	People			Roads	/X		

FOR USE BY EVERYONE www.cert-la.com 10/08/01

Summary of all hazards in area - fill out this form on your way to Command Post and give it to Incident Command.  
 (\* for structure damage: h=heavy, m=moderate, l=light)  
 Incident Command: Choose an incident, put a slash in the assignment completed column, copy the address/location to the incident name section on Incident Briefing, and give Incident Briefing and Assignment Status to incident team leader. Copy address/location to Post-Incident Status and enter start time. When incident is complete, put a backslash in the assignment completed column and the incident end time on the Post-Incident Status form.

**COMMUNITY EMERGENCY RESPONSE TEAM  
CERT FORMS**

**Personnel Resources**

<b>Date:</b>		<b>Person Reporting:</b>					<b>Page #:</b>	
<b>Print Name and Time In</b>			<b>Skill Specialty Rank From 1-5 or Print "No"</b>					
<b>Name</b>	<b>Time In</b>	<b>Time Assigned</b>	<b>Fire</b>	<b>Medical</b>	<b>S&amp;R</b>	<b>Transport</b>	<b>Document</b>	<b>Other</b>

FOR USE BY LOGISTICS AND STAGING      www.cert-la.com      10/08/01

Have people sign in and mark their special skills. When you assign someone to a team, circle that team's box next to their name and enter the time assigned. When someone returns from an assignment, draw a line through their name and all boxes and have the person sign in again. Remember to check how long people have been assigned and who hasn't been assigned yet.

**COMMUNITY EMERGENCY RESPONSE TEAM  
CERT FORMS**

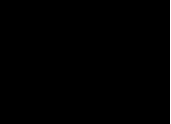

**Equipment Resources**

<b>Date:</b>	<b>Person Reporting:</b>	<b>Page #:</b>
--------------	--------------------------	----------------

		Fire Extinguisher	Wrench	Flashlight	First Aid Kit	Blankets						
Time:	Loaned To:											

FOR USE BY LOGISTICS AND STAGIN www.cert-la.com 10/08/01

Enter equipment and supplies as they come in and out. Total periodically.  
If an item is returned empty (for instance, a fire extinguisher), add it back in and circle the number, so you don't include it in your next total.

**COMMUNITY EMERGENCY RESPONSE TEAM  
CERT FORMS**

**Incident Briefing**

<b>Prepared By:</b>	<b>Date:</b>	<b>Time:</b>
<b>Incident Name:</b>		
<b>Map Sketch:</b>		
<b>Current Organization:</b>	<b>Incident Commander:</b>	<b>Battalion:</b>
<b>Summary of Current Actions</b> <i>Be aware of hazards! Work as a team!</i>		

FOR INCIDENT COMMANDER

[www.cert-la.com](http://www.cert-la.com)

10/08/01

Incident Command: Transfer an incident from Damage Assessment sheet. Sketch a map of the incident area, if known, with any hazards. Enter Incident Commander's name and Battalion number under current organization. Give to incident team leader with Assignment Status sheet.

Incident team leader: Sketch a map of the incident area with any hazards, if not done by Incident Command. Summarize the actions of your teams. When incident is complete, return this form, along with Assignment Status, to Incident Command.



**COMMUNITY EMERGENCY RESPONSE TEAM  
CERT FORMS**



**Message Form**

<b>To:</b>	<b>Message Center Use Only</b> Incident : _____ Time: _____ Date: _____ <input type="checkbox"/> Incoming <input type="checkbox"/> Outgoing
<b>From:</b>	
<b>Time:</b>	
<b>Message Text:</b>	
<b>Action Taken:</b>	

USE CLEAR CONCISE TEXT www.cert-la.com 10/08/01  
Examples: assignment completed, additional resources needed, unable to complete, special information/status update.

**COMMUNITY EMERGENCY RESPONSE TEAM  
CERT FORMS**

**Incident Status**

Date:	Person Reporting:		Page:
Address/Location	Assignment	Start Time	End Time

FOR INCIDENT COMMAND

[www.cert-la.com](http://www.cert-la.com)

10/08/01

Record incident assignments from Damage Assessment sheets. When incident is complete, enter end time and make a backslash for that incident on the Damage Assessment.

COMMUNITY EMERGENCY RESPONSE TEAM  
CERT FORMS

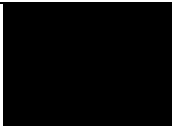

Victim Treatment Area Record

Person Reporting:				Page #:	
Date:	Name or Descr	Triage Tag	Condition	Moved To:	Time Out

FOR MEDICAL TREATMENT AREA [www.cberf.com](http://www.cberf.com) 10/08/0

Document each person brought to the treatment area with a brief description of the injury, the person's condition, and the person's name.

Tag color: red=Immediate, yellow=Delayed, blue=Minor.



---

# UNIT 7: DISASTER PSYCHOLOGY

---

---

**In this unit you will learn about:**

- **Disaster Psychology:** The psychological impact of a disaster on rescuers and victims, and how to provide “psychological first aid.”
- **Caring for Yourself, Your Buddy, and Victims:** Steps one can take individually and as part of a CERT before, immediately following, and after a disaster.



**UNIT 7: DISASTER PSYCHOLOGY**

---

**INTRODUCTION AND UNIT OVERVIEW**

CERT members should prepare themselves for their role during and following a disaster by learning about the possible impact of disaster on them and others, emotionally and physically. This knowledge will help CERT members understand and manage their reactions to the event and to work better with others.

This unit will address techniques for managing one's personal situation so that the needs of the victims and those of CERT team members can be met.

At the end of this unit, you should be able to:

- Describe the disaster and post-disaster emotional environment.
  - Describe the steps that rescuers can take to relieve their own stress and those of disaster survivors.
- 

**TEAM WELL-BEING**

During a disaster, you may see and hear things that will be extremely unpleasant.

Vicarious trauma is the process of change in the rescuer resulting from empathic engagement with survivors. It is an "occupational hazard" for helpers.

Do not overidentify with the survivors. Do not take on the survivors' feelings as your own. Taking ownership of others' problems will compound your stress and affect the CERT's overall effectiveness.

Be alert to signs of disaster trauma in yourself, as well as in disaster victims, so that you can take steps to alleviate stress.

**TEAM WELL-BEING (CONTINUED)**

Psychological symptoms may include:

- Irritability or anger.
- Self-blame or the blaming of others.
- Isolation and withdrawal.
- Fear of recurrence.
- Feeling stunned, numb, or overwhelmed.
- Feeling helpless.
- Mood swings.
- Sadness, depression, and grief.
- Denial.
- Concentration and memory problems.
- Relationship conflicts/marital discord.

Physiological symptoms may include:

- Loss of appetite.
- Headaches or chest pain.
- Diarrhea, stomach pain, or nausea.
- Hyperactivity.
- Increase in alcohol or drug consumption.
- Nightmares.
- The inability to sleep.
- Fatigue or low energy.



**TEAM WELL-BEING (CONTINUED)**

There are steps that CERT team leaders can take to promote team well-being before, during, and after an incident:

- Provide pre-disaster stress management training to all CERT personal.
- Brief CERT personnel before the effort begins on what they can expect to see and what they can expect in terms of emotional response in the survivors and themselves.
- Emphasize that the CERT is a team. Sharing the workload and emotional load can help defuse pent-up emotions.
- Encourage rescuers to rest and re-group so that they can avoid becoming overtired.
- Direct rescuers to take breaks away from the incident area, to get relief from the stressors of the effort.
- Encourage rescuers to eat properly and maintain fluid intake throughout the operation. Explain that they should drink water or other electrolyte-replacing fluids, and avoid drinks with caffeine or refined sugar.
- Rotate teams for breaks or new duties (i.e., from high-stress to low-stress jobs). Team members can talk with each other about their experiences. This is very important for their psychological health.
- Phase out workers gradually. Gradually phase them from high- to low-stress areas of the incident.
- Conduct a brief discussion (defusing) with workers after the shift, in which workers describe what they encountered and express their feelings about it.
- Arrange for a debriefing 1 to 3 days after the event in which workers describe what they encountered and express their feelings about it in a more in-depth way.

CERT leaders may invite a mental health professional trained in Critical Incident Stress Management (CISM) to conduct a Critical Incident Stress Debriefing (CISD).

A CISD is a formal group process held between 1 to 3 days after the event and is designed to help emergency services personnel and volunteers cope with a traumatic event.

**TEAM WELL-BEING (CONTINUED)**

You should spend some time thinking about other ways to reduce stress personally. Only you know what makes you able to reduce stress within yourself. Expending the effort required to find personal stress reducers is worthwhile before an incident occurs. You can take the following preventive steps in your everyday life:

- Get enough sleep.
- Exercise.
- Eat a balanced diet.
- Balance work, play, and rest.
- Allow yourself to receive as well as give. Remember that your identity is broader than that of a helper.
- Connect with others.
- Use spiritual resources.

Experienced rescue workers find these steps helpful in controlling their stress levels, but, in some cases, it might be necessary to seek help from mental health professionals.

CISD is one type of interventions within a more comprehensive, multicomponent crisis intervention system that is based on a careful assessment of the needs of a group or individual. CISD should not be used as a stand-alone intervention with other types be used in conjunction with other types of intervention.

A CISD has seven phases:

- Introductions and a description of the process, including assurance of confidentiality
- Review of the factual material about the incident
- Sharing of initial thoughts/feelings about the incident
- Sharing of emotional reactions to the incident
- Review of the symptoms of stress experienced by the participants
- Instruction about normal stress reactions
- Closing and further needs assessment

**TEAM WELL-BEING (CONTINUED)**

Participation in CISD should be voluntary.

To schedule a CISD, you should contact the Red Cross, local emergency management agency, or community mental health agency. You could also ask your local fire or police department for help in contacting the appropriate person.

---

**WORKING WITH SURVIVORS' TRAUMA**

Some research studies have indicated that survivors go through emotional phases following a disaster:

- In the impact phase, survivors do not panic and may, in fact, show no emotion.
- In the inventory phase, which immediately follows the event, survivors assess damage and try to locate other survivors. During this phase, routine social ties tend to be discarded in favor of the more functional relationships required for initial response activities (e.g., search and rescue).
- In the rescue phase, emergency services personnel (including CERTs) are responding and survivors are willing to take their direction from these groups without protest. This is why CERT identification (helmets, vests, etc.) is important.
- In the recovery phase, the survivors appear to pull together against their rescuers, the emergency services personnel.

You should expect that survivors will show psychological effects from the disaster—and some of the psychological warfare will be directed toward you.

A crisis is an event that is experienced or witnessed in which people's ability to cope is overwhelmed:

- Actual or potential death or injury to self or others.
- Serious injury.
- Destruction of their homes, neighborhood, or valued possessions.
- Loss of contact with family members or close friends.

**WORKING WITH SURVIVORS' TRAUMA (CONTINUED)**

Traumatic stress may affect:

- Cognitive functioning. Those who have suffered traumatic stress may act irrationally, have difficulty making decisions; or may act in ways that are out of character or them normally. They may have difficulty sharing or retrieving memories.
- Physical health. Traumatic stress can cause a range of physical symptoms—from exhaustion to heart problems.
- Interpersonal relationships. Those who survive traumatic stress may undergo temporary or long-term personality changes that make interpersonal relationships difficult.

The strength and type of personal reaction vary because of:

- The victim's prior experience with the same or a similar event. The emotional effect of multiple events can be cumulative, leading to greater stress reactions.
- The intensity of the disruption in the survivors' lives. The more the survivors' lives are disrupted, the greater their psychological and physiological reactions may become.
- The meaning of the event to the individual. The more catastrophic the victim perceives the event to be to him or her personally, the more intense will be his or her stress reaction.
- The emotional well-being of the individual and the resources (especially social) that he or she has to cope. People who have had other recent traumas may not cope well with additional stressors.
- The length of time that has elapsed between the event's occurrence and the present. The reality of the event takes time to "sink in."

You should not take the survivors' surface attitudes personally. Rescuers may expect to see a range of responses that will vary from person to person, but the responses they see will be part of the psychological impact of the event—and probably will not relate to anything that the CERTs have or have not done.

**WORKING WITH SURVIVORS' TRAUMA (CONTINUED)**

The goal of on-scene psychological intervention on the part of CERT members should be to stabilize the incident scene by stabilizing individuals. Do this in the following ways:

- Assess the survivors for injury and shock. Address any medical needs first. Observe them to determine their level of responsiveness and whether they pose a danger to themselves or to others.
- Get uninjured people involved in helping. Focused activity helps to move people beyond shock, so give them constructive jobs to do, such as running for supplies. This strategy is especially effective for survivors who are being disruptive.
- Provide support by:
  - Listening to them talk about their feelings and their physical needs. Victims often need to talk about what they've been through—and they want someone to listen to them.
  - Empathizing. Show by your responses that you hear their concerns. Victims want to know that someone else shares their feelings of pain and grief.
- Help survivors connect to natural support systems, such as family, friends, or clergy.

Survivors that show evidence of being suicidal, psychotic, or unable to care for themselves should be referred to mental health professionals for support. (This will be infrequent in most groups of survivors.)

When providing support, they should avoid saying the following phrases. On the surface, these phrases are meant to comfort the survivors, but they do not show an understanding of the person's feelings.

- "I understand." In most situations we cannot understand unless we have had the same experience.
- "Don't feel bad." The survivor has a right to feel bad and will need time to feel differently.
- "You're strong/You'll get through this." Many survivors do not feel strong and question if they will recover from the loss.
- "Don't cry." It is ok to cry.
- "It's God's will." Giving religious meaning to an event to a person you do not know may insult or anger the person.

**WORKING WITH SURVIVORS' TRAUMA (CONTINUED)**

- “It could be worse” or “At least you still have ...” It is up to the individual to decide whether things could be worse.

These types of responses could elicit a strong negative response or distance the survivor from you.

It is ok to apologize if the survivor reacts negatively to something that you said.

One unpleasant task that CERT members may face is managing the family members at the scene of the death of a loved one. The guidelines below will help you deal with this situation:

- Cover the body; treat it with respect. Wrap mutilated bodies tightly.
- Have one family member look at the body and decide if the rest of the family should see it.
- Allow family members to hold or spend time with the deceased. Stay close by, but don't watch—try to distance yourself emotionally somewhat.
- Let the family grieve. Don't try to comfort them out of a need to alleviate your own discomfort.

In some cases, the family may not know of the death of their loved one, and CERT members may be called upon to tell them. Suggest that in this situation, CERT members:

- Separate the family members from others in a quiet, private place.
  - Have the person(s) sit down, if possible.
  - Make eye contact and use a calm, kind voice.
  - Use the following words to tell the family members about the death: “I'm sorry, but your family member has died. I am so sorry.”
-

---

# UNIT 8: TERRORISM AND CERT

---

---

**In this unit you will learn about:**

- **What Terrorism Is:** The definition of terrorism and terrorist goals.
- **Terrorist Weapons:** The weapons that terrorists are known or are suspected to have and the risk posed by various terrorist weapons.
- **B-NICE Indicators:** Cues that help to identify a when a terrorist attack has occurred or may be imminent.
- **CERTs and Terrorist Incidents:** CERT protocols for terrorist incidents and protective action following an event.





**UNIT 8: TERRORISM AND CERT**

---

**INTRODUCTION AND UNIT OVERVIEW**

In his January 29, 2002, State of the Union address, the President asked Americans to volunteer their services to improve and safeguard our country and created the Citizen Corps program to help Americans meet this call to service.

One of the volunteer opportunities offered to the American public under the Citizen Corps umbrella is the CERT program.

Given the increased threat of terrorist attacks on American soil, CERT members must be educated about CERT protocols and procedures for terrorist incidents and the actions that CERTs should take following a possible terrorist attack.

At the end of this unit, you should be able to:

- Define terrorism.
  - Identify potential targets in the community.
  - Identify CERT operating procedures for a terrorist incident.
  - Describe the actions to take following a suspected terrorist incident.
-

### **WHAT IS TERRORISM?**

The U.S. Department of Justice's definition of terrorism is:

. . .the unlawful use of force or violence committed by a group or individual against persons or property to intimidate or coerce a government, the civilian population, or any segment thereof, in furtherance of political or social objectives.

Terrorism may be perpetrated by foreign or domestic individuals or groups. While the United States has not had as many terrorist incidents as some other countries, we have had several serious attacks, including:

- The bombing of the World Trade Center (1993).
- The bombing of the Murrah Federal Building in Oklahoma City (1995).
- The bombing at the Atlanta Olympic Games (1996).
- Bombings at family planning clinics and gay bars in the Atlanta area (1996 and 1997).
- The destruction of the World Trade Center and a portion of the Pentagon (2001).
- The sending of anthrax through the U.S. Mail (2001).

Each of these incidents demonstrates that we live with the possibility of additional terrorist attacks on our own soil.

Terrorist attacks can occur with or without warning. Because of the nature of terrorist attacks, they can—and are often intended to—result in:

- Mass casualties.
- Loss of critical resources.
- Disruption of vital services.
- Disruption of the economy.
- Individual and mass panic.

### TERRORIST TARGETS

Terrorists choose their targets to meet their goals. For example, the Oklahoma City bombing was a strike against the Federal government that caused mass panic in the Oklahoma City area. The 9/11 attacks struck both our economy and our military establishment, while raising casualty levels to new heights and changing the way America thinks about its safety.

Terrorist select “soft” or lightly protected targets over “hard” or very secure targets.

Terrorists may also be drawn to major events such as parades or athletic events. Because of this, you may see increased security measures to help deter and prevent terrorism.

---

### TERRORIST WEAPONS

Experts generally agree that there are five categories of possible terrorist weapons. The acronym B-NICE will help you to remember.

The weapons thought to be available to at least some terrorist groups include:

- Biological weapons
  - Nuclear weapons and radiological dispersal devices
  - Incendiary devices
  - Chemical weapons
  - Explosive devices
1. **Biological weapons.** Biological agents are found in nature. Some countries, however, have devised ways to weaponize biological agents so that they can be disseminated to affect broad segments of the population, animal populations, or crops.

Some biological agents are contagious, but many are not. Routes of exposure for biological weapons are:

- Inhalation.
- Ingestion.
- Absorption.

Many, but not all, biological agents take days or even weeks for their symptoms to appear. It is possible for a biological attack to occur and remain unnoticed for some time.

**TERRORIST WEAPONS (CONTINUED)**

It is also possible for some biological agents to spread far beyond their initial point of contamination as the daily routines of affected individuals broaden the reach of the agent.

Fortunately, most biological agents are very delicate and are easily destroyed by heat, light, and other environmental factors. Additionally, the technical complexities of milling agents small enough for them to remain suspended in the air is beyond the capability of most terrorist groups.

2. **Nuclear weapons.** A terrorist attack with a nuclear weapon would be much different from an attack with a conventional explosive device. There would be potential for physical injury and death to persons who were not injured in the initial attack. The affected area would be much larger than in a conventional attack, and debris and other usually harmless items would be contaminated. The long-term health effects would be more difficult to ascertain and manage. Fortunately, experts believe that the complexities of a terrorist group obtaining a nuclear weapon and maintaining the tolerances that are required for the weapon to function make the use of nuclear weapons by terrorist groups a low risk.

Radiation dispersal devices (RDDs) are considered to be a much higher threat because radiological materials are much easier to obtain than enriched nuclear materials and the technology required to detonate an RDD is similar to that involved in detonating conventional explosives.

Radiological materials are readily available in hospitals and other medical facilities, in university science laboratories, and in many products with commercial uses. Terrorists who would attack using an RDD would need relatively small amounts of radioactive material (removed from an x-ray machine, for example) to make an effective device.

3. **Incendiary devices.** Incendiary devices are mechanical, electrical, or chemical devices used intentionally to initiate combustion and start a fire. Incendiary devices consist of three basic components:
  - An igniter or fuse
  - A container or body
  - An incendiary material or filler

Incendiary devices are relatively easy to make. A device containing a chemical incendiary would usually be metal or other nonbreakable material (but not plastic because many chemicals are corrosive); a device containing a liquid incendiary material would usually be a breakable material such as glass.

4. **Chemical agents.** Unlike biological agents or nuclear materials, which are difficult to produce or purchase, the ingredients used to produce chemical weapons are found in common products and petrochemicals. Terrorists can turn these common products into lethal weapons.

**TERRORIST WEAPONS (CONTINUED)**

There are five categories of chemical weapons:

- Blister agents cause blisters, burns, and other tissue damage. Exposure may be made through liquid or vapor contact with any exposed skin, inhalation, or ingestion. Blister agents include several families of chemicals, including mustard and lewisite. The effects of blister agents may be similar to those experienced with riot control agents (e.g., CS gas) but do not clear upon movement into fresh air. In fact, the effects of most blister agents increase with time and may not reach their full impact for 12 to 18 hours.
  - Blood agents are absorbed into the bloodstream and deprive blood cells of oxygen. Exposure may be made through liquid or vapor contact with any exposed skin, inhalation, or ingestion. Blood agents include two main families of chemicals, including hydrogen cyanide and cyanogen chloride. Those who are affected by blood agents may appear “bluish” across the nose and cheeks and around the mouth. As the symptoms of blood agents progress, the victim will convulse and lose consciousness.
  - Choking agents attack the lungs. Following exposure through inhalation, the lungs fill with fluid, which prevents oxygen from being absorbed by, and carbon dioxide from being removed from, the blood. Death results from lack of oxygen and is similar to drowning. Two common examples of choking agents are phosgene and chlorine.
  - Nerve agents affect the central nervous system. These agents act most quickly and are the most lethal of all chemical agents, acting within seconds of exposure. Victims of nerve agents experience constricted pupils, runny nose, shortness of breath, convulsions, and cessation of breathing. Sarin is an example of a nerve agent.
  - Riot-control agents cause respiratory distress and tearing and are designed to incapacitate rather than kill. Riot-control agents cause intense pain, especially in the moist areas of the body. Common riot-control agents include CS (also known as “tear” gas) and capsicum (also called pepper spray).
5. Conventional explosives have been the “weapon of choice” for most terrorists who have used them in more than 80 percent of attacks. While terrorists have used military munitions such as grenades, mortars, and shoulder-fired surface-to-air missiles, experts rate conventional explosives in the form of improvised explosive devices as a greater threat.

Improvised explosive devices (IEDs) include any device that is created in an improvised manner, incorporating explosives or other materials designed to destroy, disfigure, distract, or harass. Most bombs used by terrorists are improvised. The raw materials required for many explosives can be purchased commercially (e.g., ammonium nitrate, which is also used as fertilizer), purchased from commercial blasting supply companies, or developed using readily available household ingredients.

## TERRORIST WEAPONS (CONTINUED)

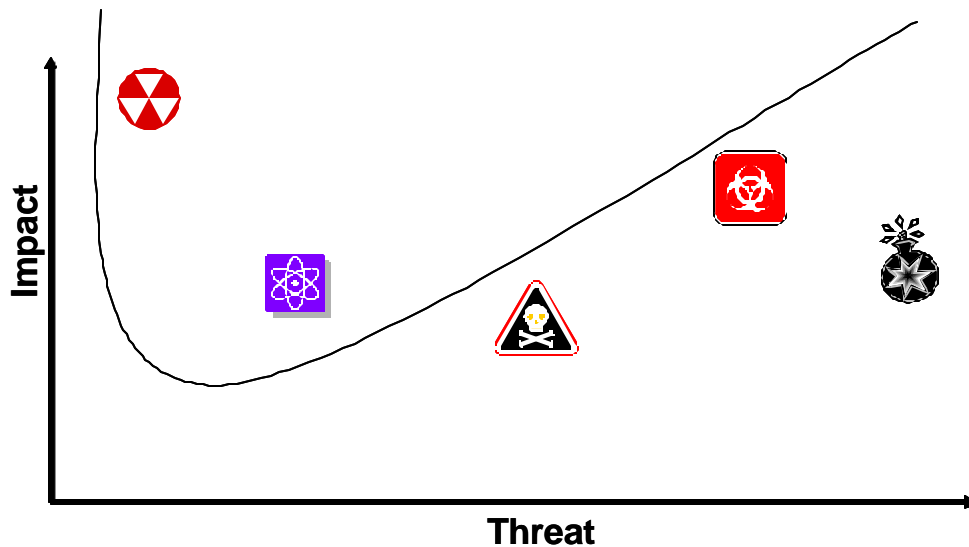

This graphic illustrates the impact versus the likelihood of the various types of terrorist weapons. Remember that:

- Although nuclear weapons present the highest impact, they are considered the lowest risk because of the difficulty in obtaining enough weapons-grade material and the technical complexity of developing and maintaining the tolerances required for a nuclear device to detonate.
- Incendiary, chemical, and conventional devices are considered higher-risk but lower-impact weapons.
- Biological weapons are considered both high-risk and high-impact weapons—but only for diseases that are highly contagious. Other types of biological weapons (i.e., those requiring dispersal devices) are considered a lower risk because of the sensitivity of the biological agents to heat, light, and shock.

**B-NICE INDICATORS**

You need to be alert to changes in the environment as a clue to a possible terrorist attack.

Environmental indicators of a biological or chemical attack could include:

- Numerous sick or dead animals, fish, or birds. Wildlife are often more sensitive to chemical or biological agents than humans. Animals, fish, or birds that are obviously sick, dying, or dead may indicate the presence of a biological or chemical attack.
- Unscheduled spraying or abandoned spray devices. Several September 11 terrorists are known to have made inquiries into purchasing and learning to fly crop dusters. Many other types of agricultural sprayers can be used to disperse biological and (more likely) chemical agents.
- Vapor clouds or mists that are unusual for the area or for the time of day. Although many biological and chemical agents cannot be seen with the naked eye, the substances in which they are suspended when dispersed may be visible for a period of time after an attack.
- The absence of crops, wildlife, or insects that are common for the area, time of day, or time of year. Being aware of what is not in the environment that should be is as important as being aware of what is in the environment but is out of place.
- Out of place and unattended packages, boxes, or vehicles. Terrorists have a long history of hiding explosive devices in packages, boxes, or vehicles. Items that are out of place and unattended could signal a possible terrorist attack.
- Packages that are leaking may be harmless—but they may also signal a terrorist incident. The terrorists who released Sarin in the Tokyo subway system (Aum Shinrikyo) merely poked holes in bags containing Sarin, then left the area as the poison leaked out.
- Materials or equipment that are unusual for the area. Dispersal devices, lab equipment, or quantities of hazardous materials that are not typically located in the area may indicate that a terrorist attack is occurring or is about to occur.
- Small explosions that disperse liquids, mists, or gases are an obvious sign that something is wrong.
- Unusual odors or tastes.

**B-NICE INDICATORS (CONTINUED)**

You may observe physical indications of a terrorist attack. Some possible physical indicators include:

- Multiple casualties without obvious signs of trauma. This may indicate a biological or chemical attack.
- Multiple victims who are exhibiting similar symptoms. Symptoms may range from difficulty breathing to skin necrosis to uncontrolled salivating, uncontrolled muscle twitching, or convulsions. All of these symptoms indicate that a chemical attack may have taken place.
- Large numbers of persons seeking medical attention with similar symptoms that are not characteristic of the season. The symptoms of many biological agents mimic the flu or other common illnesses. An unusually large number of persons seeking medical attention for the flu in July could indicate that a biological attack has taken place.

---

**PREPARING AT HOME AND WORK**

Because team safety is the first priority, CERT members should treat possible terrorist incidents as a stop sign. CERTs are not equipped or trained to respond to terrorist incidents.

There are ways to prepare for a terrorist incident. Some of the steps for preparing for a terrorist incident are the same as for natural hazards but some require special planning.

The steps to take to prepare for a terrorist attack include:

- Assembling a disaster supply kit. Disaster supplies for terrorist incidents are the same as for other hazards and should definitely include a battery-powered radio with extra batteries and a cordless or cellular telephone. Those who live in high-risk areas (such as those who live within the 10-mile emergency planning zone around a nuclear facility) will be provided with additional information by their local emergency management agencies.
- Identifying a safe room in the home or workplace and a meeting place outside of the home or workplace. Because the public will not know in advance whether to evacuate or shelter in place, it is necessary to plan for both. Because many chemicals are heavier than air, a safe room in the house should be on the main level or second level (not in the basement) and should have as few doors and windows as possible. A meeting place outside of the home should be outside of the area and upwind from the incident.



**PREPARING AT HOME AND WORK (CONTINUED)**

- Develop a family communication plan. Depending on the family members' locations at the time of an attack, it may not be possible to get to the meeting place. Identifying an out-of-state or out-of-area contact or other family communication plan will facilitate the knowledge that family members are safe.
- Learn shelter-in-place procedures and prepare a sheltering kit. Shelter-in-place procedures for a chemical or biological attack include are shown in the visual.

Procedures for sheltering in place during a chemical or biological attack include:

- Shutting off the ventilation system and latching all doors and windows to reduce airflow from the outside.
- Using pre-cut plastic sheeting to cover openings where air can enter the room, including doors, windows, vents, electrical outlets, and telephone outlets! When cut, the sheeting should extend several inches beyond the dimensions of the door or window to allow room the duct tape the sheeting to the walls and floor.
- Taping the plastic sheeting around all doors and windows using duct tape to ensure a good seal.
- Seal with duct tape other areas where air can come in, such as under doors and areas where pipes enter the home. Air can be blocked by placing towels or other soft objects in areas where air could enter, then securing them with duct tape.
- Listen to a battery-powered radio for the all clear. Chemicals used in an attack will be carried on the wind and will dissipate over time. Listen to EAS broadcasts to know when it is safe to leave the safe room.

---

**CERTS AND TERRORIST INCIDENTS**

Remember that:

- Team safety is the number one priority. All CERT members owe it to themselves and their loved ones not to become victims while trying to help others.
- Always do a thorough sizeup and stop, look, listen, and think before taking any action. Consider:
  - Dangers, both existing and possible.
  - Team capabilities, including how many CERT members are available, the training that they have had, and the equipment that is available at the scene.
  - Team limitations.

**CERTS AND TERRORIST INCIDENTS (CONTINUED)**

CERT protocols for terrorist incidents:

- As with hazardous materials, terrorist incidents are a stop sign for CERT members.
- Take in the whole area during the sizeup. If any of the indicators of a terrorist incident are present, do not proceed with the response.

If terrorism using WMD is suspected, CERTs will be very limited in what they can do. Professional responders will need specialized equipment and personnel to respond to a terrorist incident.

If you observe any of the indicators of a terrorist incident, you should:

- Not touch it!
- Move away from the object or area.
- Report it to authorities immediately.

Cellular phones and two-way radios create static electricity and may detonate explosive devices. CERT members should always report suspected explosive devices via landline.

**SELF-CARE DURING TERRORIST INCIDENTS**

It is important to know what actions to take in a terrorist incident.

There are three factors that significantly affect safety at a terrorist incident:

- Time. Limiting the amount of time in the area of an incident limits exposure.
- Distance. Evacuate the area. Professional responders suggest maintaining distance of between 1,000 and 1,500 feet from the incident. Move upwind and uphill from the incident site.
- Shielding. The shielding provided by a sturdy building or even a wall can increase protection from contamination, radiation, or blast effects.

Time, distance, and shielding requirements are based on an initial sizeup of the situation. If you are inside a building that is not damaged and you are not in immediate danger, you should listen to Emergency Alert System (EAS) broadcasts for information about whether to evacuate or shelter in place.

### CERTS AND TERRORIST INCIDENTS (CONTINUED)

If there are any reason to believe that chemical, or radiological contamination has occurred in your area put distance between you and the agent. If exposed to a chemical agent or radiation, use basic decontamination procedures.

Be sure to make the points listed below:

- Leave the contaminated area immediately (at least 1,000 to 1,500 feet upwind and uphill) to limit the time of exposure and reduce contamination levels.
- Take decontamination action. Seconds count! The goal is to limit the time that the agent is in contact with the skin.
  - Remove everything from the body, including jewelry. Cut off clothing that would normally be removed over the head to reduce the probability of inhaling the agent.
  - Wash hands before using them to shower.
  - Flush the entire body, including the eyes, underarms, and groin area, with copious amounts of cool water. Hot water opens the pores of the skin and can promote absorption of the contaminant. Using copious amounts of water is important because some chemicals react to small amounts of water.

If soap is immediately available, mix the soap with water for decontamination. Avoid scrubbing with soap because scrubbing can reduce the layer of protective skin, thus increasing absorption of the contaminant.

If working with a buddy, work together to decontaminate each other. If hosing someone else off, avoid both physical contact with the person and with the runoff.

- Blot dry using an absorbent cloth. Do not rub the skin! Put on clean clothes.
- Report for decontamination as soon as possible. Professional responders will be setting up decontamination stations somewhere around the site.

**CERTS AND TERRORIST INCIDENTS (CONTINUED)****TREATING OTHERS**

The first priority for CERT teams is personal safety. CERT members should take self-protective measures only. You should not attempt to treat victims in the contaminated area. CERT members can tell people who are leaving the area about using basic decontamination procedures and waiting for responders.

**WHAT PROFESSIONAL RESPONDERS WILL DO**

There are several measures that you can expect professional responders to take when you arrive at the scene of a terrorist incident.

The first step that professional responders will take when they arrive at the scene is to conduct a thorough sizeup. You will follow steps that are very similar to those that CERTs take to determine:

- What is going on.
- How bad the situation is and how much worse it could get.
- What measures can be taken to control the incident safely.
- What resources will be needed.

CERTs can expect professional responders to treat terrorist incidents much the same as hazardous materials incidents. As such, the next step that they will take is to establish three incident zones to minimize the risk of spreading contamination from the incident site.

- The hot zone includes the incident scene and the contaminated area around the scene. If the incident is outdoors, the hot zone will spread downwind, taking wind speed into consideration.
  - The warm zone is upwind from the hot zone and is used to isolate victims during decontamination. It is called the warm zone because the evacuees can carry or spread a contaminant into this area. Professional responders will hold those who require decontamination in the warm zone until decontamination is complete so that contaminants do not spread.
  - The cold zone is located upwind and beyond the warm zone. Those who are not contaminated or who have been decontaminated will be evacuated to the cold zone and kept there until professional responders authorize them to leave.
-

**Activity: Applying CERT Principles to a Suspected Terrorist Incident**

**Purpose:** The purpose of this activity is to enable you to apply CERT protocols to a suspected terrorist incident.

**Instructions:** Follow the steps below to complete this activity:

1. Assume that you are a CERT graduate and have been assigned to a team.
  2. Working in your table group, read the scenario assigned to your group and determine as a team what actions to take.
  3. You will have 10 minutes to read and discuss your scenarios.
  4. Select a spokesperson to present the team's response to the class.
- 

**Scenario 1:**

It is a bright, sunny spring day. You are stopping at the Post Office on your way home from work. As you enter the parking lot, you are shaken by an explosion and see glass from the Post Office windows fly through the air across the parking lot. Although it takes you a few seconds, you realize that there has been an explosion inside the Post Office.

**Scenario 2:**

It is a bright sunny day. You are stopping at the Post Office on your way home from work. As you enter the parking lot, you see several people exiting the building. All seem to be disoriented. Some are clutching their chests and rubbing their eyes. One has fallen to the ground and seems to be having some sort of convulsion.

**UNIT SUMMARY**

Terrorism may be perpetrated by foreign or domestic individuals or groups. Terrorists attack to:

- Intimidate the government or the civilian population.
- Further their objectives.

When terrorists attack, their goals are to:

- Create mass casualties.
- Disrupt critical resources, vital services, and the economy.
- Cause individual and mass panic.

Terrorist groups are known to have—or are suspected of having—five types of weapons.

Using the acronym B-NICE will help you to remember the types of weapons that terrorists might be expected to use.

There are a range of environmental and physical indicators for terrorist attacks. Paying attention to what is not present in the environment that should be is as important as what is present that should not be.

CERT members should treat possible terrorist incidents the same as they would HazMat incidents—as a stop sign. If they observe indicators of a possible terrorist incident, they should:

- Not touch it!
- Move away from the object or area.
- Report it to authorities immediately.

CERTs can help limit their exposure to the harmful effects of terrorist weapons by:

- Limiting their exposure time.
- Evacuating the area to a minimum distance of 1,000 to 1,500 feet upwind and uphill.
- Using the protection of a sturdy building as shielding.

**UNIT SUMMARY (CONTINUED)**

CERT members should take immediate action to protect themselves and, if exposed, follow basic decontamination procedures immediately. Because the safety of CERT members is the number one priority, CERT members should not attempt to treat anyone who has been contaminated or perform decontamination procedures for them.

Terrorist incident scenes are crime scenes. CERT members should avoid taking any action that may disturb potential evidence.

---





---

# UNIT 9: COURSE REVIEW AND DISASTER SIMULATION

---

---

**This unit includes:**

- **A Review of Key Points from the Course.**
- **A Final Exercise.**



**UNIT 9: COURSE REVIEW AND DISASTER SIMULATION**

---

**INTRODUCTION AND UNIT OVERVIEW**

This unit is the culmination of all that you have learned throughout the course. After a brief review of the key points of the course, you will have the opportunity to use your skills and knowledge of CERT organization and operations in a simulated disaster exercise.

---

**COURSE REVIEW**

The following are key points of the disaster preparedness unit:

- Home and workplace preparedness:
  - Assembling a disaster supply kit
  - Developing a disaster plan
  - Developing a safe room
  - Evacuation versus sheltering in place
- Specific preparedness measures for high-risk hazards (including terrorism)

The following are key points from the fire safety unit:

- Hazardous materials:
  - Identification
  - Defensive strategies
- Utility control:
  - Gas
  - Electric
  - Water
- Sizeup: Stress the importance of CERT sizeup and the steps in the sizeup process.
- Firefighting resources:
  - General resources available
  - Interior wet standpipes, including operation and limitations (if applicable)
  - Portable fire extinguishers, their capabilities and limitations

**COURSE REVIEW (CONTINUED)**

- Safety considerations:
  - Safety equipment must be used at all times.
  - CERT members must always use the buddy system.
  - Fire suppression group leaders should always have a back-up team available.

The following are key points for disaster medical operations:

- The “killers”
- Head-Tilt/Chin-Lift method of opening an airway
- Methods for controlling bleeding:
  - Direct pressure
  - Elevation
  - Pressure points
- Treatment for shock:
  - Patient position
  - Maintenance of body temperature
  - No food or drink
- Conducting triage
- Head-to-toe assessments
- Wound care
- Special considerations when head, neck, or spinal injuries are suspected
- Treatment area considerations
- Splinting and bandaging



**COURSE REVIEW (CONTINUED)**

The following are key points for light search and rescue:

- Search and rescue are really two functions.
- Goals of search and rescue:
  - Rescuing the greatest number of people in the shortest amount of time
  - Rescuing the lightly trapped victims first
- Sizeup:
  - Construction types
  - Related hazards
- Structural damage:
  - Light damage
  - Moderate damage
  - Heavy damage
- Search techniques:
  - Be systematic and thorough
  - Mark areas searched
  - Document search results
- Rescue techniques:
  - Leverage and cribbing
  - Lifts and drags

**COURSE REVIEW (CONTINUED)**

The following are key points for CERT organization:

- Organizational structure:
  - Well-defined management structure
  - Effective communications among agency personnel
  - Accountability
- Command objectives:
  - Identify the scope of the incident through damage assessment
  - Determine an overall strategy and logistical requirements
  - Deploy resources efficiently but safely

The following are key points for disaster psychology:

- In the aftermath of disasters, survivors and disaster workers can experience psychological and physiological symptoms.
- The steps CERT leaders should take to reduce stress on team members.
- The steps CERT members can take to reduce their own stress levels.
- Strategies for helping survivors work through their trauma.

The following are key points for terrorism:

- B-NICE indicators
  - CERT protocols for terrorist incidents
  - Protective actions following a terrorist incident
-



**EXERCISE CRITIQUE AND SUMMARY**

It is important to continue education and training to maintain and improve your skills and knowledge. You should attend:

- Periodic refresher training that is offered locally.
  - Standard and advanced first aid courses that are offered through The American Red Cross.
  - Cardiopulmonary resuscitation classes that are offered through the American Heart Association.
-

